

XAL 23

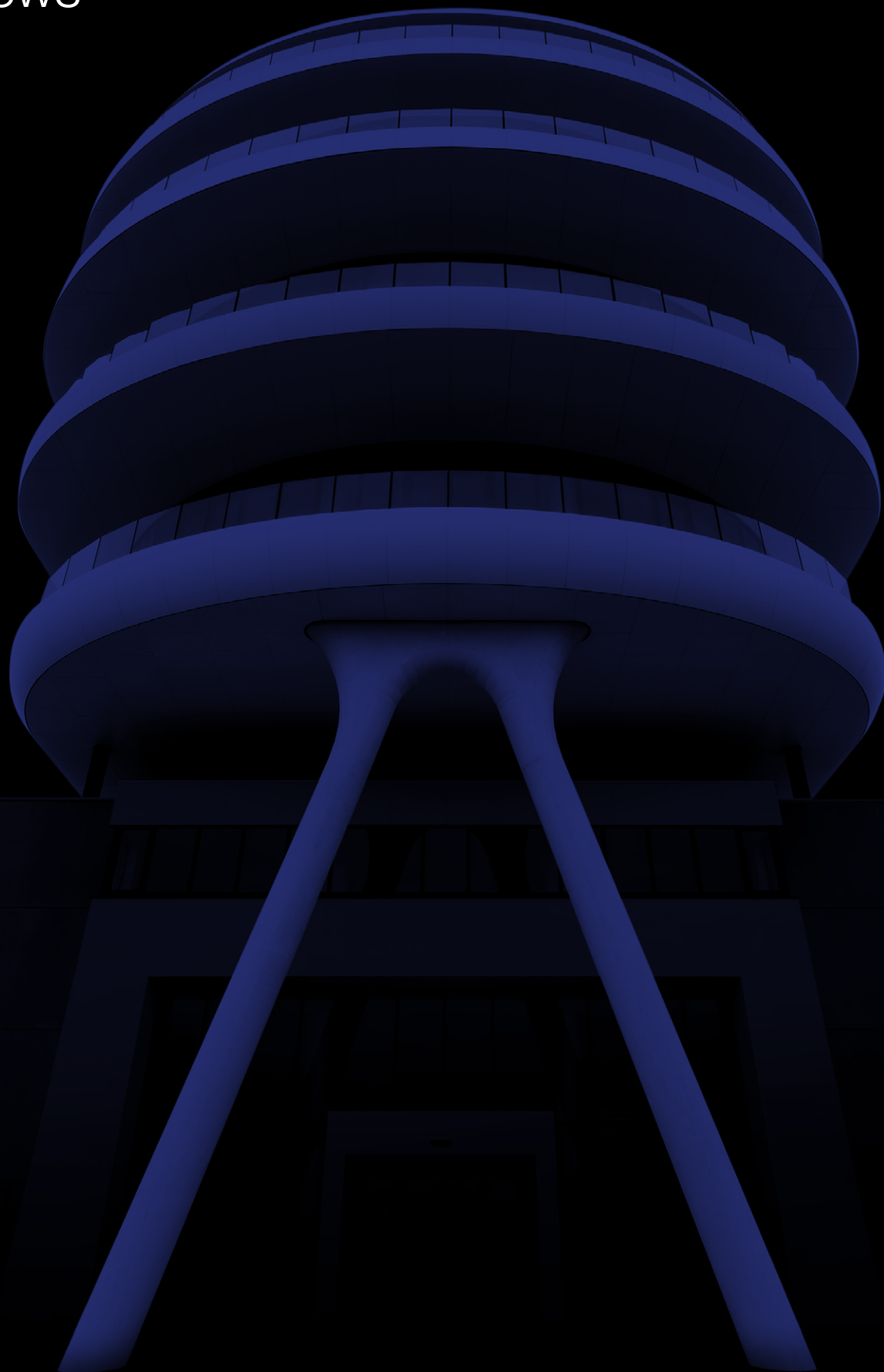

EN FR

News

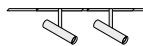

# Contents

## MOVE IT 10 installation track

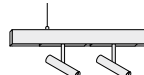
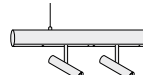
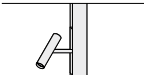

				
recessed trimless <b>12</b>	surface square <b>12</b>	suspended square <b>14</b>	suspended round <b>14</b>	pole square/round <b>16</b>

4

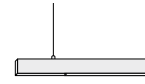
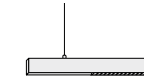
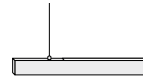
## linear insets

			
SPOT LINE direct <b>20</b>	OPAL direct <b>20</b>	DARKLIGHT direct <b>20</b>	indirect <b>20</b>

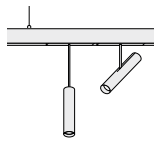
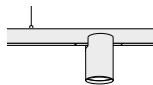
## decorative insets

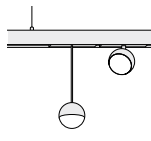
			
TILA <b>24</b>	TARO <b>32</b>	GIRA <b>36</b>	NOBA <b>40</b>

## TUBO 60 surface

		suspended		
system <b>48</b>	CONEX system <b>48</b>		system <b>48</b>	CONEX system <b>48</b>

44

## SETA ceiling

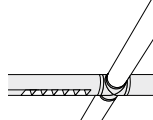
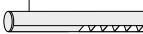
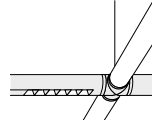
		suspended		
system <b>48</b>	CONEX system <b>48</b>		system <b>48</b>	CONEX system <b>48</b>



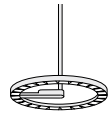

44

## MITA ceiling

	suspended	
circle <b>58</b>		suspended <b>64</b>

54

## SPIO recessed

			
20 downlight <b>72</b>	20 wallwasher <b>72</b>	60 downlight <b>76</b>	60 adjustable <b>76</b>

68

## SQUADRO recessed

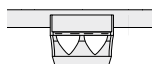
	track	
wallwasher <b>84</b>		wallwasher <b>88</b>

80

**BO**  
intrack

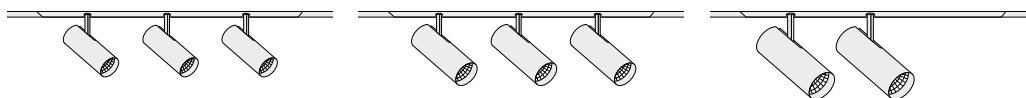

32  
2/3 lamps  
**96**

45  
2/3 lamps  
**96**

55  
1/2 lamps  
**96**

**92**

**VARO**  
track

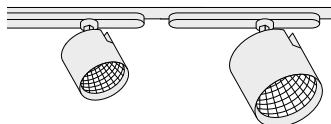

80 S  
**104**

110 S  
**108**

**102**

**MILA**  
ceiling



system  
**116**

**112**

**FRAME 40**  
recessed  
trim

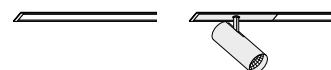

system  
**124**

system  
**130**

**120**

**MINO 40**  
ceiling

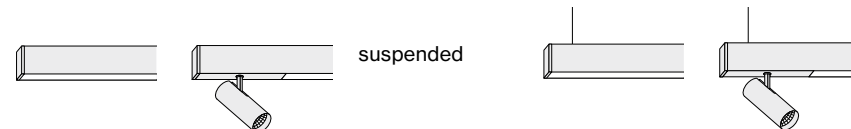

system  
**128**

system  
**130**

40 system  
**128**

40 system  
**130**

**120**



# MOVE IT 10 system

**EN** MOVE IT 10 is a particularly slim track system. The dimmable low-voltage track, available as a recessed, surface-mounted, suspended or pole version, is impressive thanks to its unusually slender cross-section. Both the round and square forms have a clear width of only 10 mm. MOVE IT 10's design is minimalistic. The insets' adapter are fully hidden in the track. The tracks are available in black, white and chrome (standard for the round version). They are connected by Corner or Curve elements for an edgy or softly rounded appearance. Extend MOVE IT 10 with various linear or design-oriented insets for maximum planning freedom for your interior concept.

**FR** Un rail d'alimentation ultra fin - c'est MOVE IT 10. Le rail d'alimentation basse tension à intensité variable, disponible en version encastrée, apparente, suspendue ou en Pole, se distingue par sa section particulièrement fine : en version ronde ou carrée, sa largeur ne dépasse pas les 10 mm. Le design minimaliste se retrouve également dans les adaptateurs, qui disparaissent complètement dans les rails. Les rails sont disponibles en noir, blanc et chrome (pour la forme ronde). Ils sont reliés par des éléments Corner ou Curve pour former, au choix, des angles précis ou des courbes harmonieuses. MOVE IT 10 peut être complété par différents inserts linéaires ou design - pour une plus grande liberté dans la planification de votre concept d'intérieur.

## Types



square      round

## Mountings

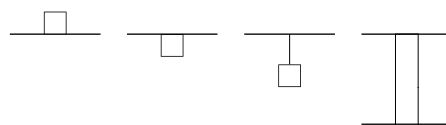

recessed      surface      suspended      pole

## Configurations



linear      curve      L-connector      T-connector      X-connector      level connector      ceiling to wall connector

## Light distributions

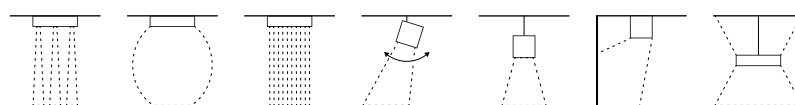

spot line      opal      darklight      spotlight      decorative      wallwasher floor      direct indirect

## Mounting options

**EN** Depending on the desired appearance and installation, the 48V track system is available as a trimless recessed-mounted, surface-mounted, suspended or pole version.

**FR** En fonction de l'esthétique et du montage voulu, le système de rail d'alimentation de 48V est disponible en version encastrée sans bord, en version apparente, en version suspendue ou en Pole.



## Create individual arrangements

**EN** Let your creativity run wild and arrange MOVE IT 10 at will. Special Curve and Corner elements enable the straight tracks to be connected to form harmonious curves or precise corners. Since all elements fit together, you can configure your ideal bespoke system.

**FR** Laissez libre cours à votre créativité et configurez votre MOVE IT 10 au gré de vos envies. Les éléments spéciaux Curve et Corner permettent de raccorder entre eux les rails rectilignes pour ainsi former des courbes harmonieuses ou des angles précis. Tous les éléments étant compatibles entre eux, vous pouvez personnaliser le système selon vos envies du moment et de l'espace à disposition.

## Track shapes

**EN** In both the round and square form, the track opens options for flexible application. Their track diameter is only 29mm, presenting a reduced and sleek appearance. Many insets offer an optional flush adapter to create an even, visually calm ceiling appearance.

**FR** De forme ronde ou carrée, le rail d'alimentation offre de multiples possibilités d'utilisation avec une grande flexibilité. Son diamètre ne dépasse pas les 29 mm, pour une apparence élégante et épurée. Les inserts sont en outre équipés d'un adaptateur affleurant qui contribue à l'harmonie d'un plafond à l'esthétique apaisante.

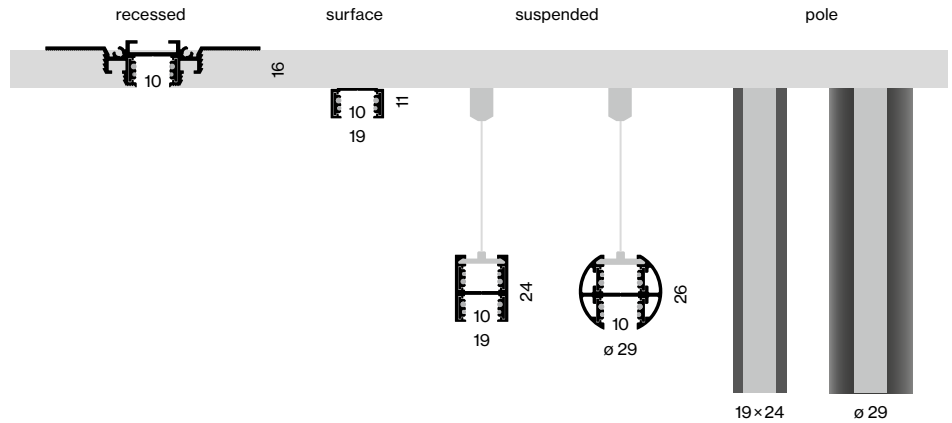

## Colour variety

**EN** The tracks are available in the colours black and white, delivering discreet elegance. The round track comes additionally in chrome. In addition, for some insets you have the choice between the trend colours chrome, rose gold, gun metal, brushed aluminium and brushed brass.

**FR** Discrète élégance : les rails d'alimentation sont disponibles en noir et en blanc. Le rail de forme ronde est en outre proposé en version chromée. De plus, vous avez le choix, pour certains inserts, entre les teintes tendance rosé, chrome, gun metal, aluminium brossé et laiton brossé.

### Installation tracks

<b>recessed square</b>	<input type="checkbox"/>	<input checked="" type="checkbox"/>	<input type="checkbox"/>
<b>surface square</b>	<input type="checkbox"/>	<input checked="" type="checkbox"/>	<input type="checkbox"/>
<b>suspended square</b>	<input type="checkbox"/>	<input checked="" type="checkbox"/>	<input type="checkbox"/>
<b>suspended round</b>	<input type="checkbox"/>	<input checked="" type="checkbox"/>	<input checked="" type="checkbox"/>
<b>pole square</b>	<input type="checkbox"/>	<input checked="" type="checkbox"/>	<input type="checkbox"/>
<b>pole round</b>	<input type="checkbox"/>	<input checked="" type="checkbox"/>	<input checked="" type="checkbox"/>

### Decorative insets

<b>GIRA</b>	<input type="checkbox"/>	<input checked="" type="checkbox"/>	<input type="checkbox"/>	<input type="checkbox"/>	<input type="checkbox"/>	<input type="checkbox"/>	<input type="checkbox"/>
<b>NOBA</b>	<input type="checkbox"/>	<input checked="" type="checkbox"/>	<input type="checkbox"/>	<input type="checkbox"/>	<input type="checkbox"/>	<input type="checkbox"/>	<input type="checkbox"/>
<b>TARO</b>	<input type="checkbox"/>	<input checked="" type="checkbox"/>	<input type="checkbox"/>	<input type="checkbox"/>	<input type="checkbox"/>	<input type="checkbox"/>	<input type="checkbox"/>
<b>TILA</b>	<input type="checkbox"/>	<input checked="" type="checkbox"/>	<input type="checkbox"/>	<input type="checkbox"/>	<input type="checkbox"/>	<input type="checkbox"/>	<input type="checkbox"/>

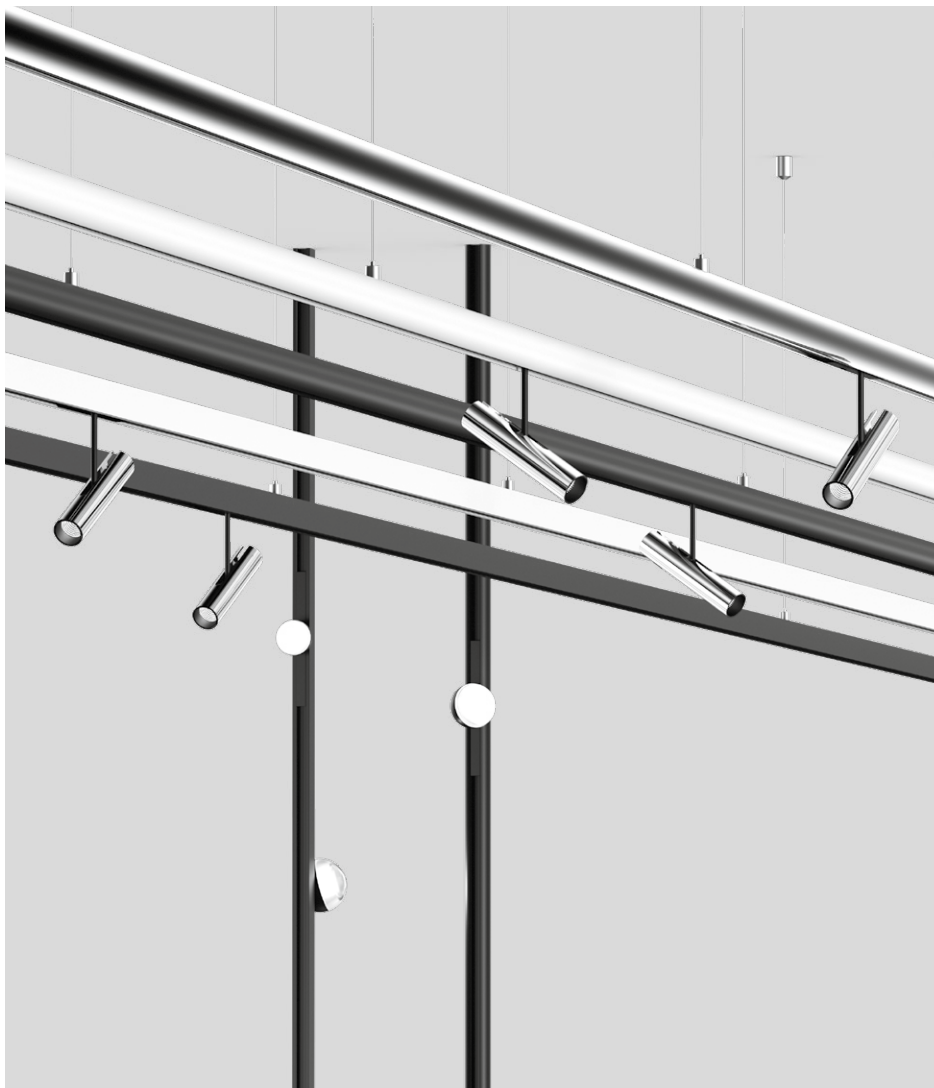

white



black

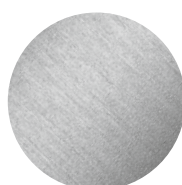

brushed aluminium

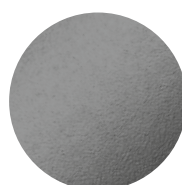

gun metal



brushed brass

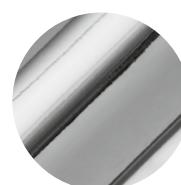

chrome

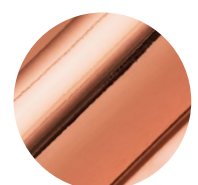

rose gold







## Mounting variety

**EN** With precise corners or harmonious curves, the MOVE IT 10 system sets no limits to creativity. Elegant insets for different applications make the track system even more flexible.

**FR** Que ce soit avec des angles précis ou des courbes harmonieuses, le système MOVE IT 10 laisse libre cours à la créativité. Des inserts élégants destinés à différentes applications offrent au système de rails une nouvelle liberté de création.

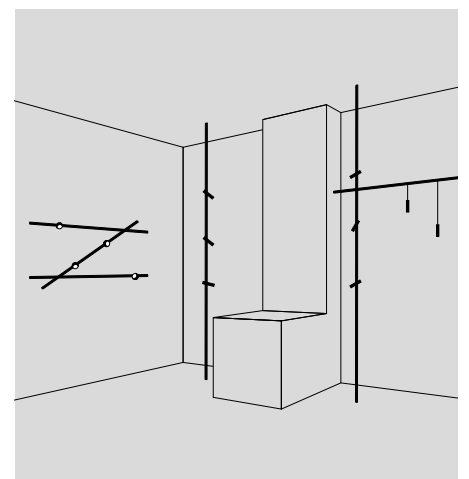
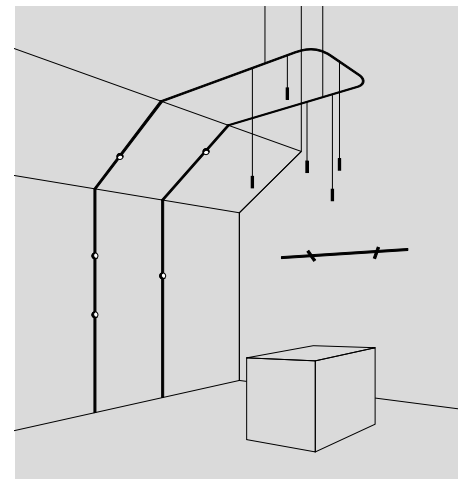
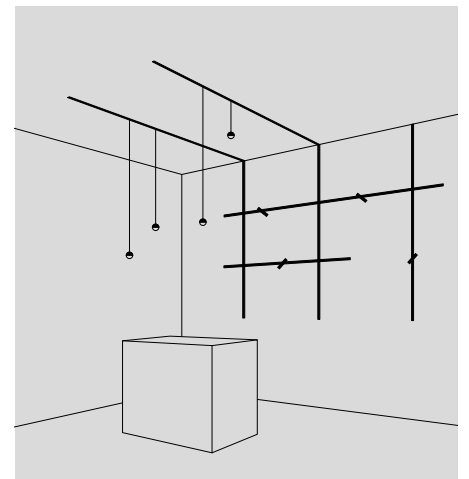



## Connector overview

**EN** A large selection of different connectors – in L-, T-, X-shape – provides even more flexibility. With the Ceiling to Wall Connector, roof slopes with different angles can also be realised.

**FR** Un large éventail de connecteurs différents - en L, en T et en X - offre encore plus de flexibilité. Le Ceiling to Wall Connector permet d'imiter la pente du toit selon différents angles.

### 1 Linear Connector



### 2 L-Connector



### 3 T-Connector



### 4 X-Connector



### 5 Flex Connector

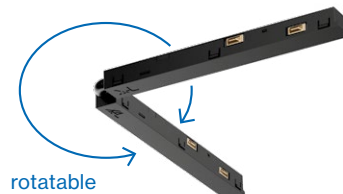

### 6 Ceiling to Wall Connector

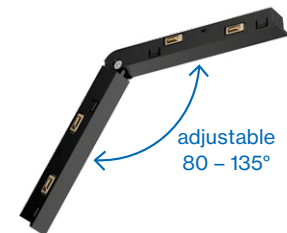

### 7 Level Connector

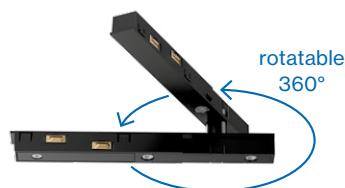

### 8 Pass Through Connector



**EN** With the Level Connector, two tracks that are placed on top of each other can now be mechanically and electrically connected to each other. This creates new application possibilities.

**EN** With the Pass Through Connector (patent pending) the direct and indirect light insets in the H-track can be electrically connected to each other.

**FR** Qui plus est, le connecteur Level assure le raccordement mécanique et électrique de deux rails passant l'un au-dessus de l'autre. Les possibilités d'application qui en résultent sont tout à fait fascinantes.

**FR** Avec le connecteur Pass Through (en passe d'être breveté) les insertions lumineuses directes et indirectes dans le rail en H peuvent être connectées électriquement les unes aux autres.

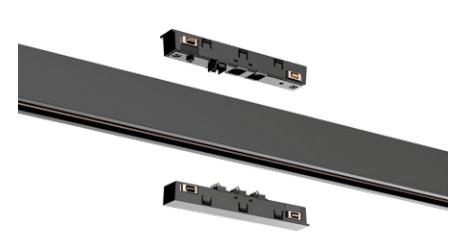
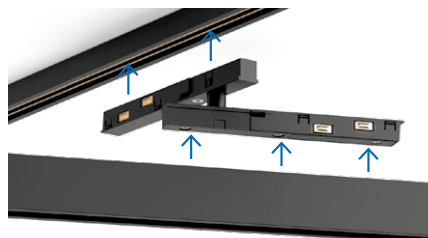

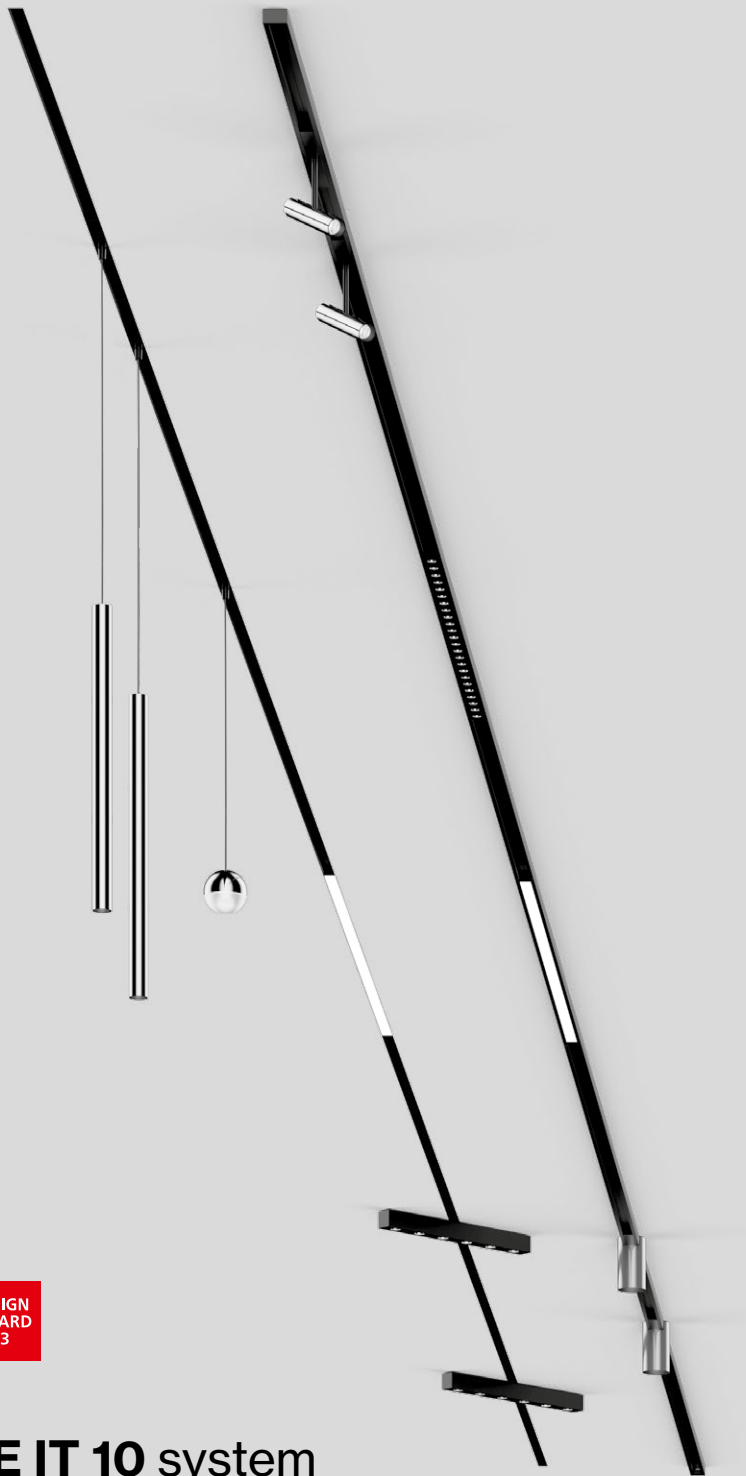

## MOVE IT 10 system

recessed trimless/surface

**EN** Thin extruded aluminium profile with 16 mm (trimless) or 11 mm (surface) height and 10 mm width groove; optionally for trimless installation in plasterboard ceilings (wall or ceiling mounting) with 12.5 mm ceiling thickness; MOVE IT 10 trimless profile with processing protection against penetration of filler; or for wall-/ceiling surface mounting; designed for continuous lighting systems; flexible system design through L, T or X connectors or by means of FLEX or LEVEL connectors; with integrated power track profile for take off of supply voltage and DALI-2 signal; surface anodised or powder coated; insets can be installed flexibly and without tools by means of clip mount

**FR** Profilé bas extrudé en aluminium de 16 mm (trimless) ou 11 mm (surface) de haut et largeur de joint de 10 mm ; au choix pour un encastrement sans bord dans des plafonds en plâtré (montage mural ou au plafond) d'une épaisseur de 12,5 mm ; profilé MOVE IT 10 trimless avec protection de finition contre les infiltrations d'enduit ; ou pour un montage en surface au mur ou au plafond ; conçu pour système d'éclairage continu ; configuration de système flexible grâce à des connecteurs en L, T ou X ou au moyen de connecteurs FLEX ou LEVEL ; avec profil de rail intégré pour fixation d'alimentation électrique et signal DALI-2 ; surface anodisée ou thermolaquée ; montage flexible et sans outil des inserts grâce à la fixation par clip

### Quickinfo

2700K, 3000K, 4000K  
CRI ≥ 90  
L90 @ 50 000h  
DALI-2

### Types

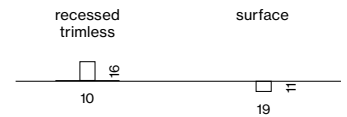

### Configurations

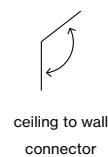
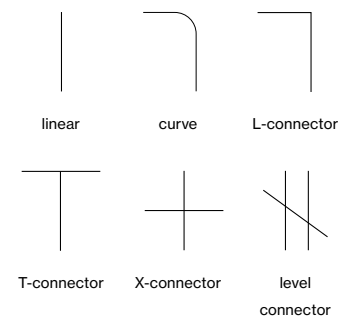

### Colours

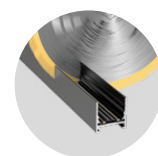

custom cut on building site

## Order options

### CONTROL

DALI-2

### MATERIAL COLOUR

- traffic white RAL 9016 7
- jet black RAL 9005 8

## Options on request

### CONNECTOR

T connector mechanical

T connector electrical

X connector mechanical

X connector electrical

only for recessed trimless

## MOVE IT 10 trimless

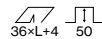
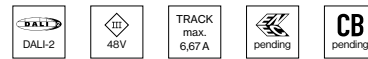

### INSTALLATION TRACK

#### L (mm)

1100	channel
2100	channel
3100	channel
custom cut	channel

#### ORDER CODE

030-1113038
030-1115038
030-1117038
E83610 ····8

\*incl. plasterin protection cover

### END CAPS / CONNECTORS

#### TYPE

end caps (pair)
linear connector electrical
L connector electrical
linear connector mechanical
L connector mechanical

#### ORDER CODE

030-1120018
030-210113
030-211113
030-1134018
030-1135018

more electrical and mechanical connectors see p. 19

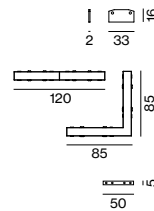

## MOVE IT 10 surface

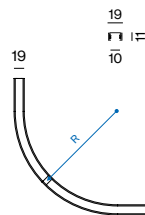
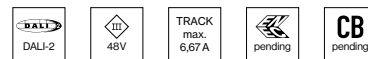

### INSTALLATION TRACK

#### L (mm)

1100	channel
2100	channel
3100	channel
custom cut	channel
R 300	curve channel
R 500	curve channel

#### ORDER CODE

030-121303
030-121503
030-121703
E83620 ····
030-123103
030-123203

### END CAPS / CONNECTORS

#### TYPE

end caps (pair)
linear connector electrical
L connector electrical
T connector electrical
X connector electrical
linear connector mechanical
L connector mechanical
T connector mechanical
X connector mechanical

#### ORDER CODE

030-122001
030-210113
030-211113
030-212113
030-213113
030-123401
030-123501
030-123601
030-123701

more electrical and mechanical connectors see p. 19

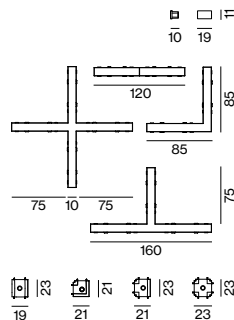

## Accessories

### BLIND COVER

#### L (mm)

1100	blind cover
2100	blind cover
3100	blind cover
custom cut	blind cover

#### ORDER CODE

030-100301
030-100501
030-100701
E83600 ····

### ELECTRICAL ACCESSORIES

#### TYPE

power feeder (only for surface)
internal power feeder (incl. cable 2000 mm)

#### ORDER CODE

030-252303
030-252503

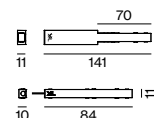

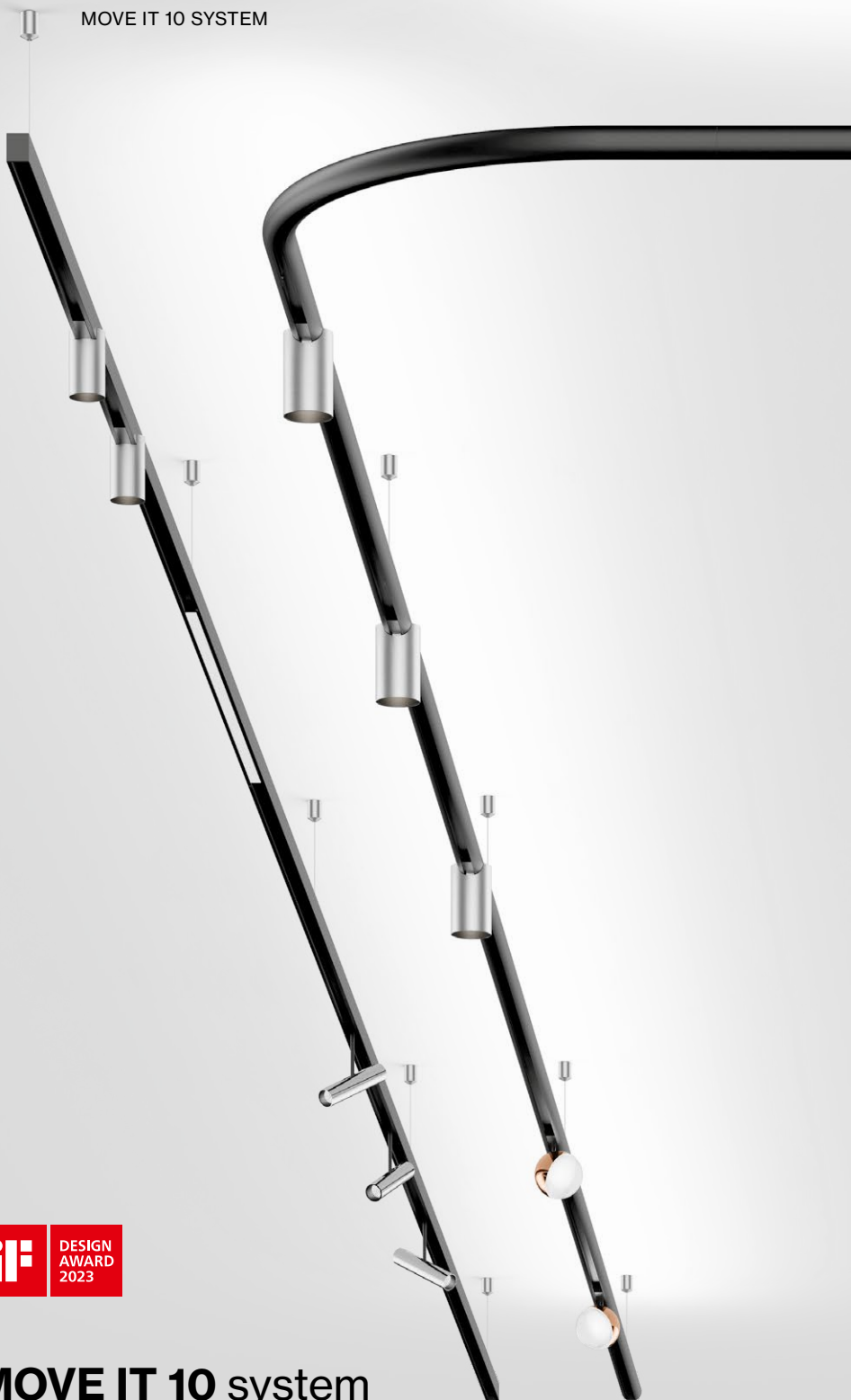

## MOVE IT 10 system

suspended

**EN** Thin extruded aluminium profile with 10 mm width groove; choice of angular (38 mm height) or tubular (28 mm height) design; for suspended mounting (cable suspension, height adjustment without tools, incl. black feed); with integrated power track profile on both sides for take off of supply voltage and DALI-2 signal; power supply and DALI-2 signal for both power tracks with only one feed by means of pass-through connector; designed for continuous lighting systems; flexible system design through L, T or X connectors or by means of LEVEL connectors; surface anodised or powder coated; insets can be installed flexibly and without tools by means of clip mount

**FR** Profilé bas extrudé en aluminium avec largeur de joint de 10 mm ; forme angulaire (38 mm de haut) ou tubulaire (28 mm de haut) au choix ; pour montage suspendu (suspension par câble, réglage en hauteur sans outil, câble d'alimentation noir inclus) ; avec profilé de rail d'alimentation intégré des deux côtés pour la tension d'alimentation et le signal DALI-2 ; alimentation et signal DALI-2 pour les deux rails avec arrivée unique grâce à des connecteurs de type pass through ; conçu pour système d'éclairage continu ; configuration de système flexible grâce à des connecteurs en L, T ou X ou au moyen de connecteurs LEVEL ; surface anodisé ou thermolaquée ; montage flexible et sans outil des inserts grâce à la fixation par clip

### Quickinfo

2700K, 3000K, 4000K  
CRI ≥ 90  
L90 @ 50 000h  
DALI-2

### Types

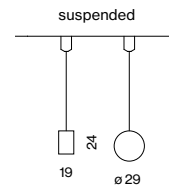

### Configurations

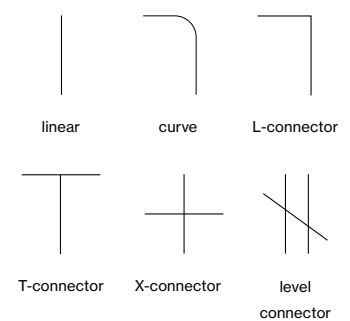

### Colours

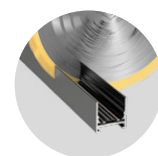

custom cut on building site

### Order options

#### CONTROL

DALI-2

#### MATERIAL COLOUR

- traffic white RAL 9016 7
- jet black RAL 9005 8

#### MATERIAL COLOUR

#### CABLE SUSPENSION

- chrome 4
- jet black RAL 9005 8

### Options on request

#### MATERIAL COLOUR

#### MOVE IT 10 ROUND

- chrome

### MOVE IT 10 square suspended

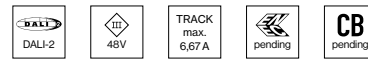

#### INSTALLATION TRACK

L (mm)		ORDER CODE
1100	channel	030-131303
2100	channel	030-131503
3100	channel	030-131703
custom cut	channel	E83630
R 300	curve channel	030-133103
R 500	curve channel	030-133203

#### END CAPS / CONNECTORS

TYPE	ORDER CODE
end caps (pair)	030-132001
linear connector electrical	030-210113
L connector electrical	030-211113
T connector electrical	030-212113
X connector electrical	030-213113
linear connector mechanical	030-133401
L connector mechanical	030-133501
T connector mechanical	030-133601
X connector mechanical	030-133701

more electrical and mechanical connectors see page 19

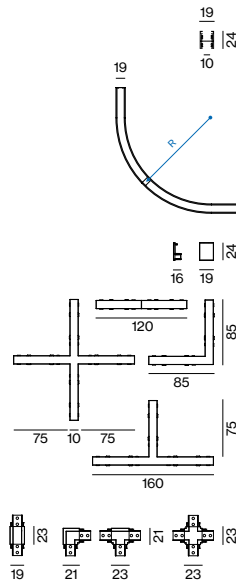

### MOVE IT 10 round suspended

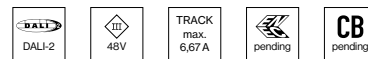

#### INSTALLATION TRACK

L (mm)		ORDER CODE
1100	channel	030-141303
2100	channel	030-141503
3100	channel	030-141703
custom cut	channel	E83640
R 300	curve channel	030-143103
R 500	curve channel	030-143203

#### END CAPS / CONNECTORS

TYPE	ORDER CODE
end caps (pair)	030-142001
linear connector electrical	030-210113
L connector electrical	030-211113
T connector electrical	030-212113
X connector electrical	030-213113
linear connector mechanical	030-143401
L connector mechanical	030-143501
T connector mechanical	030-143601
X connector mechanical	030-143701

more electrical and mechanical connectors see page 19

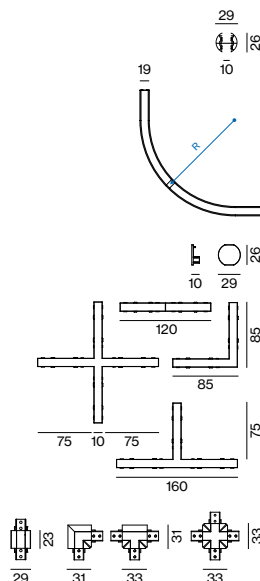

### Accessories

**BLIND COVER** see page 17

**INDIRECT LIGHT INSET** see page 17

#### CABLE SUSPENSION / CANOPY / ELECTRICAL ACCESSORIES

TYPE	L (mm)	ORDER CODE
cable suspension	1500	030-223001
cable susp. linear connector	1500	030-221001
cable susp. linear conn. electrical	1500	030-222001
canopy square	90-90-22	005-231121
canopy round	ø90-22	005-260003
internal power feeder (incl. cable 2000 mm)		030-252503
pass through connector electrical (pair)		030-217113

more electrical and mechanical connectors see page 19

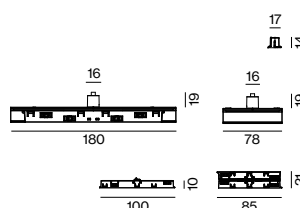



## MOVE IT 10 system

### pole

**EN** Thin extruded aluminium profile with 10 mm width groove; choice of angular (38 mm height) or tubular (28 mm height) design; for vertical and horizontal mounting; easy installation of the mounting set, incl. feed; with integrated power track profile on both sides for take off of supply voltage and DALI-2 signal; power supply and DALI-2 signal for both power tracks with only one feed by means of pass-through connector; designed for continuous lighting systems; flexible system design through L, T or X connectors or by means of LEVEL connectors; surface anodised or powder coated; insets can be installed flexibly and without tools by means of clip mount

**FR** Profilé bas extrudé en aluminium avec largeur de joint de 10 mm ; forme angulaire (38 mm de haut) ou tubulaire (28 mm de haut) au choix ; pour montage vertical et horizontal ; simplicité d'installation du kit de montage, alimentation comprise ; avec profilé de rail d'alimentation intégré des deux côtés pour la tension d'alimentation et le signal DALI-2 ; alimentation et signal DALI-2 pour les deux rails avec arrivée unique grâce à des connecteurs de type pass through ; conçu pour système d'éclairage continu ; configuration de système flexible grâce à des connecteurs en L, T ou X ou au moyen de connecteurs LEVEL ; surface anodisée ou thermolaquée ; montage flexible et sans outil des inserts grâce à la fixation par clip

### Quickinfo

2700K, 3000K, 4000K  
CRI ≥ 90  
L90 @ 50 000h  
DALI-2

### Types

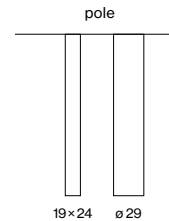

### Mounting types

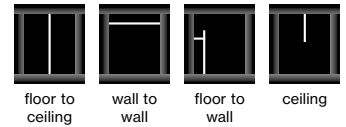

### Colours

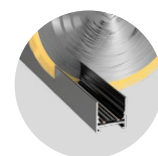

custom cut on building site



## Order options

### COLOUR TEMPERATURE

2700 K	4
3000 K	5
4000 K	6

### CONTROL

DALI-2

### MATERIAL COLOUR

○ traffic white RAL 9016	7
● jet black RAL 9005	8

## Options on request

### MATERIAL COLOUR

#### MOVE IT 10 ROUND

● chrome

## MOVE IT 10 square pole



### INSTALLATION TRACK

L (mm)		ORDER CODE
1100	channel	030-131303
2100	channel	030-131503
3100	channel	030-131703
custom cut	channel	E83630 ····

### MOUNTING SET



TYPE	ORDER CODE
floor to ceiling set (pair)	030-134101
wall to wall set (pair)	030-134101
floor to wall set (wall bracket 400 mm incl. end cap)	030-134201
ceiling set (incl. end cap)	030-134301

## MOVE IT 10 round pole



### INSTALLATION TRACK

L (mm)		ORDER CODE
1100	channel	030-141303
2100	channel	030-141503
3100	channel	030-141703
custom cut	channel	E83640 ····

### MOUNTING SET



TYPE	ORDER CODE
floor to ceiling set (pair)	030-144101
wall to wall set (pair)	030-144101
floor to wall set (wall bracket 400 mm incl. end cap)	030-144201
ceiling set (incl. end cap)	030-144301

## LIGHT INSET 10

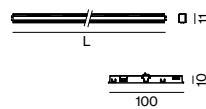

### INDIRECT incl. feeder

INS. POWER	COLOUR TEMP.	LUM. FLUX	L (mm)	ORDER CODE
15 W	2700 K	1370 lm	1000	030-6330
	3000 K	1450 lm		
	4000 K	1530 lm		
30 W	2700 K	2750 lm	2000	030-6370
	3000 K	2900 lm		
	4000 K	3050 lm		

## Accessories

### BLIND COVER

L (mm)		ORDER CODE
1100	blind cover	030-100301
2100	blind cover	030-100501
3100	blind cover	030-100701
custom cut	blind cover	E83600 ····

### ELECTRICAL ACCESSORIES

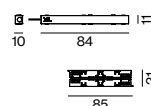

TYPE	ORDER CODE
internal power feeder (incl. cable 2000 mm)	030-252503
pass through connector electrical (pair)	030-217113

**INSET POWER** is the current consumption excluding any ballast  
**LUMINOUS FLUX** value calculated for CRI ≥ 90, colour black



## Types

- 1 Linear Connector
- 2 L-Connector
- 3 T-Connector
- 4 X-Connector
- 5 Flex Connector
- 6 Ceiling to Wall Connector
- 7 Level Connector
- 8 Pass Through Connector

## Configurations

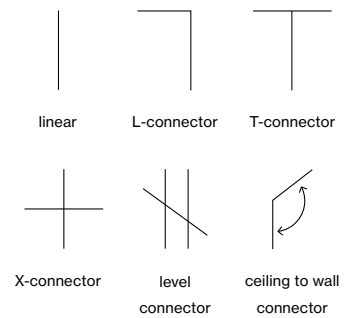

## Colours



# ELECTRICAL accessories

MOVE IT 10 system

**EN** Mechanical and electrical connectors to MOVE IT 10 system; in L-, T- or X-shape; or FLEX, CEILING TO WALL or LEVEL connectors, as well as PASS THROUGH connectors; for flexible system design; different converters for the entire MOVE IT system

**FR** Connecteurs mécaniques et électriques pour système MOVE IT 10 ; en L, T ou X ; ou connecteurs FLEX, CEILING TO WALL ou LEVEL, ainsi que connecteurs PASS THROUGH ; pour structure de système flexible ; différents convertisseurs pour le système MOVE IT complet

### Order options

CONNECTOR MECHANICAL	T
recessed*	1
surface	2
suspended square	3
suspended round	4

\*T- and X-connector on request

CONTROL
DALI-2

MATERIAL COLOUR	☑
○ traffic white* RAL 9016	7
● jet black RAL 9005	8

\*not for mechanical recessed trimless

### Options on request

CONNECTOR
T connector electrical
T connector mechanical
X connector electrical
X connector mechanical

only for recessed trimless

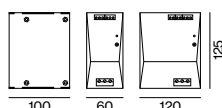
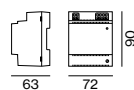
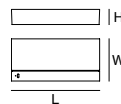
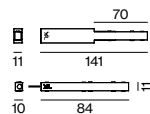
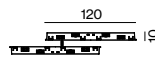
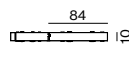
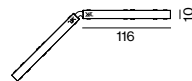
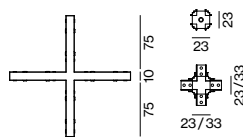
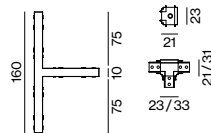
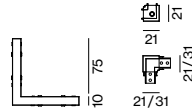
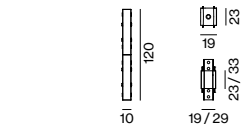

### Electrical accessories

#### LINEAR CONNECTOR

TYPE	ORDER CODE
linear connector electrical	030-210113
linear connector mechanical	030-1T3401

#### L CONNECTOR

TYPE	ORDER CODE
L connector electrical	030-211113
L connector mechanical	030-1T3501

#### T CONNECTOR

TYPE	ORDER CODE
T connector electrical	030-212113
T connector mechanical	030-1T3601

#### X CONNECTOR

TYPE	ORDER CODE
X connector electrical	030-213113
X connector mechanical	030-1T3701

#### FLEX CONNECTOR

TYPE	ORDER CODE
flex connector electrical	030-214113

#### CEILING TO WALL CONNECTOR

TYPE	ORDER CODE
ceiling to wall connector electrical	030-216113

#### LEVEL CONNECTOR

TYPE	ORDER CODE
level connector electrical	030-215113

#### PASS THROUGH CONNECTOR

TYPE	ORDER CODE
pass through connector electrical (pair)	030-217113

electrical connection from direct to indirect and vice versa

#### POWER FEEDER

TYPE	ORDER CODE
power feeder (only for surface)	030-252303
internal power feeder (incl. cable 2000mm)	030-252503

#### POWER SUPPLY EXTERNAL supply 220-240 V AC, 48V, 50-60 Hz

TYPE	EFFICIENCY	MOUNTING	L-W-H (mm)	ORDER CODE
60W □ PC II η 88%	external	163-43-32	002-62133	
150W □ PC II η 92%	external	350-30-18	002-62135	
250W □ PC II η 93%	external	400-40-22	002-62139	

ENEC approved, incl. feeder cable 2000 mm

#### POWER SUPPLY BASIC 48V

220-240 V | 50-60 Hz | □ PC II | Lifetime @ 120W, 45° ambient temp. cascable max. 3 devices

TYPE	EFFICIENCY/LIFETIME	W-H-D (mm)	ORDER CODE
160W η 94.5% / > 100.000 h	72-90-63	005-6520210	

#### DIN RAIL POWER SUPPLY PRO 48V

220-240 V | 50-60 Hz | ⊕ PC I | MTBF @ 55° ambient temperature cascable max. 5 devices (240W) or 3 devices (480W)

TYPE	EFFICIENCY/MTBF	W-H-D (mm)	ORDER CODE
240W η 92% / > 400.000 h	60-125-100	005-6220110	
480W η 93% / > 350.000 h	120-125-100	005-6220210	

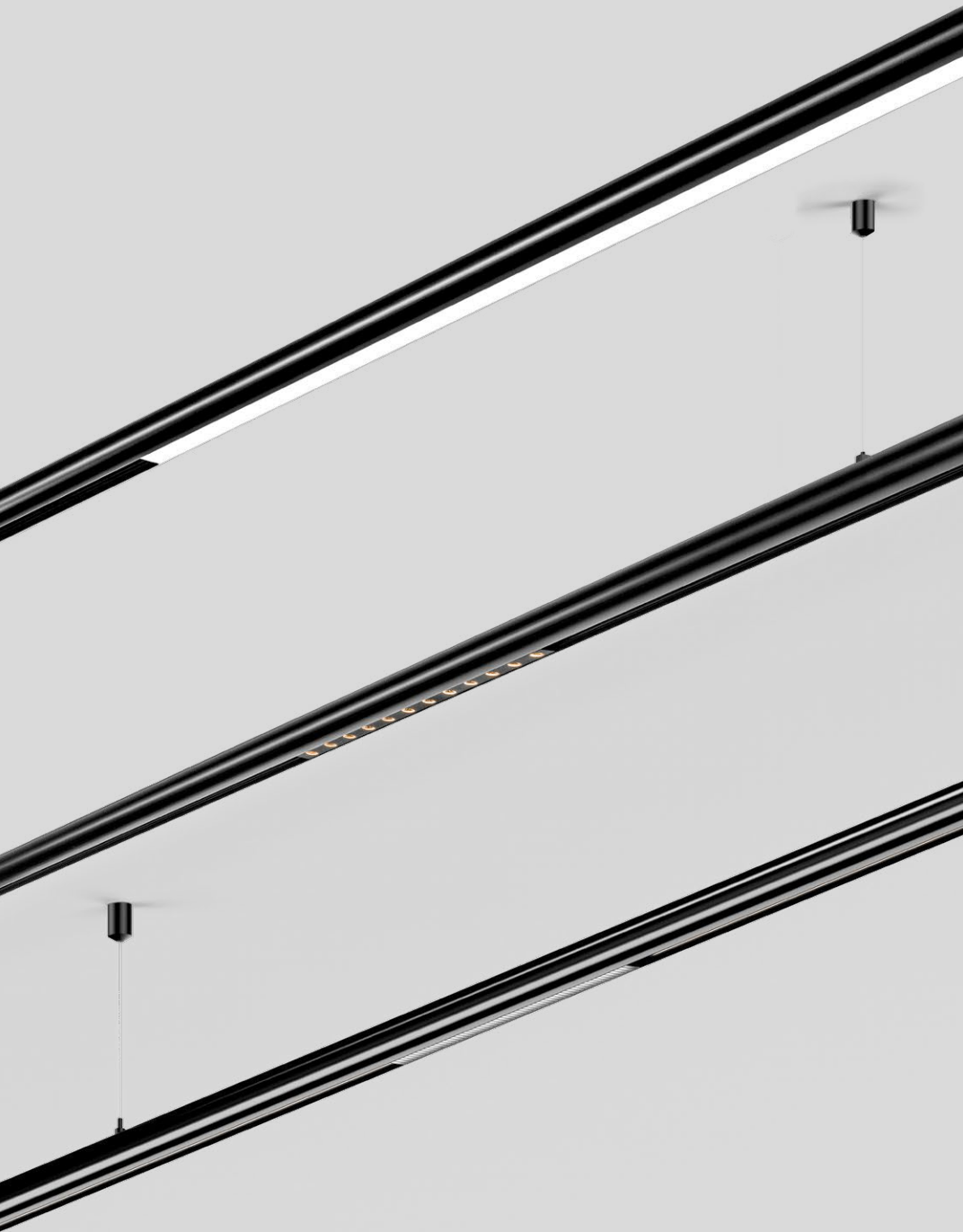

**Quickinfo**

2700 K, 3000 K, 4000 K  
 CRI ≥ 90  
 up to 105lm/W  
 DALI-2

**Types**

spot line

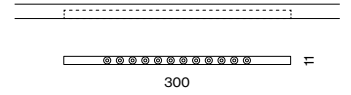

opal

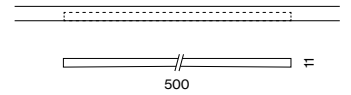

darklight

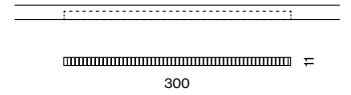

indirect

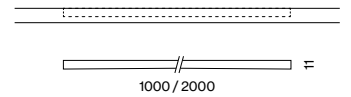

**Colour**



**Light distributions**

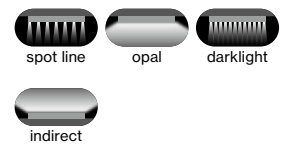

**SPOT LINE / OPAL / DARKLIGHT**

linear inset 10

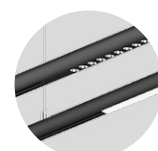

flush mounted

## Order options

### COLOUR TEMPERATURE

2700 K	4
3000 K	5
4000 K	6

### CONTROL

DALI-2

### MATERIAL COLOUR

● jet black RAL 9005

### LIGHT OPTIC

spot line  
 opal high performance  
 darklight  
 indirect

## LIGHT INSET 10

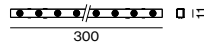

### SPOT LINE

INS. POWER	COLOUR TEMP.	LUM. FLUX	L (mm)	ORDER CODE
8.5 W	2700 K	420 lm	300	0 30 - 6 1 1 0 :: 3 8 M
	3000 K	460 lm		
	4000 K	480 lm		

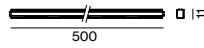

### OPAL HIGH PERFORMANCE

INS. POWER	COLOUR TEMP.	LUM. FLUX	L (mm)	ORDER CODE
5 W	2700 K	520 lm	500	0 30 - 6 1 2 0 :: 3 8 H
	3000 K	520 lm		
	4000 K	525 lm		

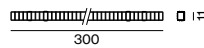

### DARKLIGHT

INS. POWER	COLOUR TEMP.	LUM. FLUX	L (mm)	ORDER CODE
5.7 W	2700 K	280 lm	300	0 30 - 6 2 1 0 :: 3 8 M
	3000 K	280 lm		
	4000 K	285 lm		

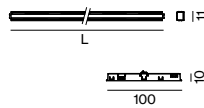

### INDIRECT incl. feeder

INS. POWER	COLOUR TEMP.	LUM. FLUX	L (mm)	ORDER CODE
15 W	2700 K	1370 lm	1000	0 30 - 6 3 3 0 :: 3 8 M
	3000 K	1450 lm		
	4000 K	1530 lm		
30 W	2700 K	2750 lm	2000	0 30 - 6 3 7 0 :: 3 8 M
	3000 K	2900 lm		
	4000 K	3050 lm		

**INSET POWER** is the current consumption excluding any ballast  
**LUMINOUS FLUX** value calculated for CRI ≥ 90, colour black

**Private Residence**  
Visualisation







**Quickinfo**

2700 K, 3000 K, 4000 K  
 CRI ≥ 90  
 up to 81lm/W  
 DALI-2

**Types**

adjustable rod

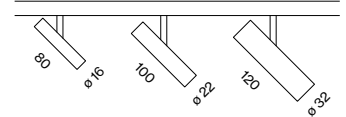

suspended

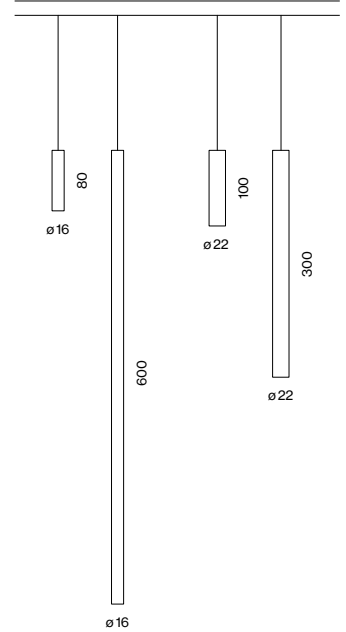

**Colours**



**Light distributions**

TILA 16



TILA 22/32

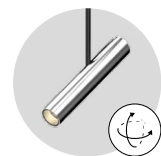

365° rotatable  
 135° tiltable

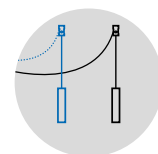

free positioning by  
 cable and hook

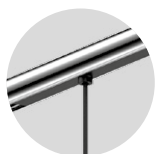

flush adapter  
 mounting



**TILA**  
 decorative inset 10



## Order options

HOUSING HEIGHT TILA 16	L
80 mm	0
600 mm	1

HOUSING HEIGHT TILA 22	L
100 mm	3
300 mm	4

COLOUR TEMPERATURE	••
2700 K	4
3000 K	5
4000 K	6

### CONTROL

DALI-2

MATERIAL COLOUR	☑
○ traffic white RAL 9016	7
● jet black RAL 9005	8
● brushed aluminium	6
● chrome	4

MATERIAL COLOUR ACCESSORIES	■
○ traffic white RAL 9016	7
● jet black RAL 9005	8

BEAM ANGLE TILA 16	▲
medium 20°	M
flood 40°	F

BEAM ANGLE TILA 22/32	▲
spot 14°	S
medium 24°	M
flood 45°	F

## Options on request

MATERIAL COLOUR	
● gun metal	
● brushed brass	
● rose gold	

## TILA 16

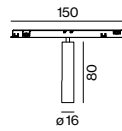

### ADJUSTABLE

INSET POWER	COLOUR TEMP.	LUMINOUS FLUX	ORDER CODE
5 W	2700 K	230lm	0 30 - 6 5 0 0 : 3 ▲▲
	3000 K	240lm	
	4000 K	250lm	

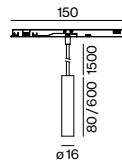

### SUSPENDED

INSET POWER	COLOUR TEMP.	LUMINOUS FLUX	ORDER CODE
5 W	2700 K	230lm	0 30 - 6 6 L 0 : 3 ▲▲
	3000 K	240lm	
	4000 K	250lm	

## TILA 22

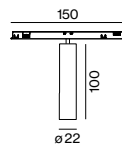

### ADJUSTABLE

INSET POWER	COLOUR TEMP.	LUMINOUS FLUX	ORDER CODE
10.5 W	2700 K	415lm	0 30 - 6 5 3 0 : 3 ▲▲
	3000 K	440lm	
	4000 K	460lm	

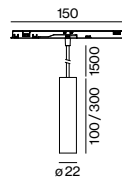

### SUSPENDED

INSET POWER	COLOUR TEMP.	LUMINOUS FLUX	ORDER CODE
10.5 W	2700 K	415lm	0 30 - 6 6 L 0 : 3 ▲▲
	3000 K	440lm	
	4000 K	460lm	

## TILA 32

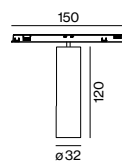
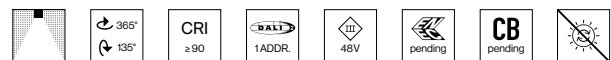

### ADJUSTABLE

INSET POWER	COLOUR TEMP.	LUMINOUS FLUX	ORDER CODE
11 W	2700 K	720lm	0 30 - 6 5 6 0 : 3 ▲▲
	3000 K	850lm	
	4000 K	900lm	

## Mounting accessories

### HOOK ceiling mounted

TYPE	Ø-H (mm)	ORDER CODE
hook	16-30	0 30 - 1 0 0 0 0 1 ■



## Optical accessories

### HONEYCOMB LOUVER

TYPE	Ø-H (mm)	ORDER CODE
TILA 22	20-3	0 0 7 - 1 9 6 5 1 1 8
TILA 32	30-3	0 0 7 - 1 9 6 5 1 6 8

**INSET POWER** is the current consumption excluding any ballast  
**LUMINOUS FLUX** value calculated for CRI≥90, colour white, medium

**Jewellery Shop**  
Visualisation





**Private Residence**  
Visualisation





**Private Residence**  
Visualisation







### Quickinfo

2700 K, 3000 K, 4000 K  
CRI ≥ 90  
up to 83 lm/W  
DALI-2

### Types

square track

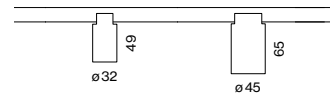

round track

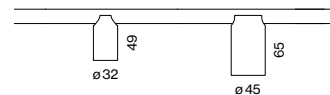

### Colours



### Light distributions

TARO 32



spot med. flood

TARO 45



med. flood wall  
floor



# TARO

decorative inset 10



wallwasher floor  
360° rotatable



wallwasher  
floor



## Order options

COLOUR TEMPERATURE	
2700 K	4
3000 K	5
4000 K	6

CONTROL	
DALI-2	

MATERIAL COLOUR	
○ traffic white RAL 9016	7
● jet black RAL 9005	8
● brushed aluminium	6
● chrome	4

BEAM ANGLE TARO 32	
spot 18°	S
medium 23°	M
flood 37°	F

BEAM ANGLE TARO 45	
medium 24°	M
flood 39°	F

## Options on request

MATERIAL COLOUR	
● gun metal	
● brushed brass	
● rose gold	

## TARO 32

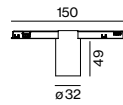
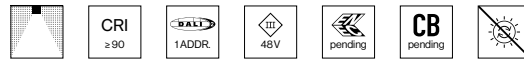

### DOWNLIGHT SQUARE TRACK

INSET POWER	COLOUR TEMP.	LUMINOUS FLUX	ORDER CODE
11W	2700 K	720lm	030-6700::3▲▲
	3000 K	860lm	
	4000 K	900lm	

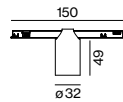

### DOWNLIGHT ROUND TRACK

INSET POWER	COLOUR TEMP.	LUMINOUS FLUX	ORDER CODE
11W	2700 K	720lm	030-6740::3▲▲
	3000 K	860lm	
	4000 K	900lm	

## TARO 45

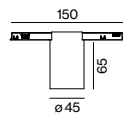
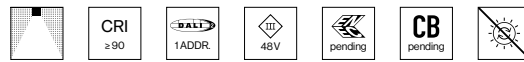

### DOWNLIGHT SQUARE TRACK

INSET POWER	COLOUR TEMP.	LUMINOUS FLUX	ORDER CODE
15W	2700 K	1000lm	030-6710::3▲▲
	3000 K	1100lm	
	4000 K	1150lm	

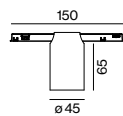

### DOWNLIGHT ROUND TRACK

INSET POWER	COLOUR TEMP.	LUMINOUS FLUX	ORDER CODE
15W	2700 K	1000lm	030-6750::3▲▲
	3000 K	1100lm	
	4000 K	1150lm	

## TARO 45 wallwasher floor

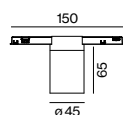
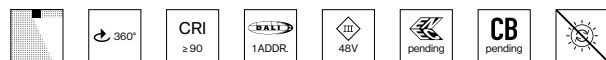

### DOWNLIGHT SQUARE TRACK

INSET POWER	COLOUR TEMP.	LUMINOUS FLUX	ORDER CODE
9W	2700 K	530lm	030-6780::3▲W
	3000 K	570lm	
	4000 K	580lm	

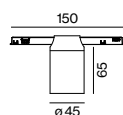

### DOWNLIGHT ROUND TRACK

INSET POWER	COLOUR TEMP.	LUMINOUS FLUX	ORDER CODE
9W	2700 K	530lm	030-6790::3▲W
	3000 K	570lm	
	4000 K	580lm	

## Optical accessories

### HONEYCOMB LOUVER

TYPE	Ø-H (mm)	ORDER CODE
TARO 32	30·4	007-1965168
TARO 45	42·3	007-1965188

**INSET POWER** is the current consumption excluding any ballast  
**LUMINOUS FLUX** value calculated for CRI≥90, colour white, medium

**Jewellery Shop**  
Visualisation

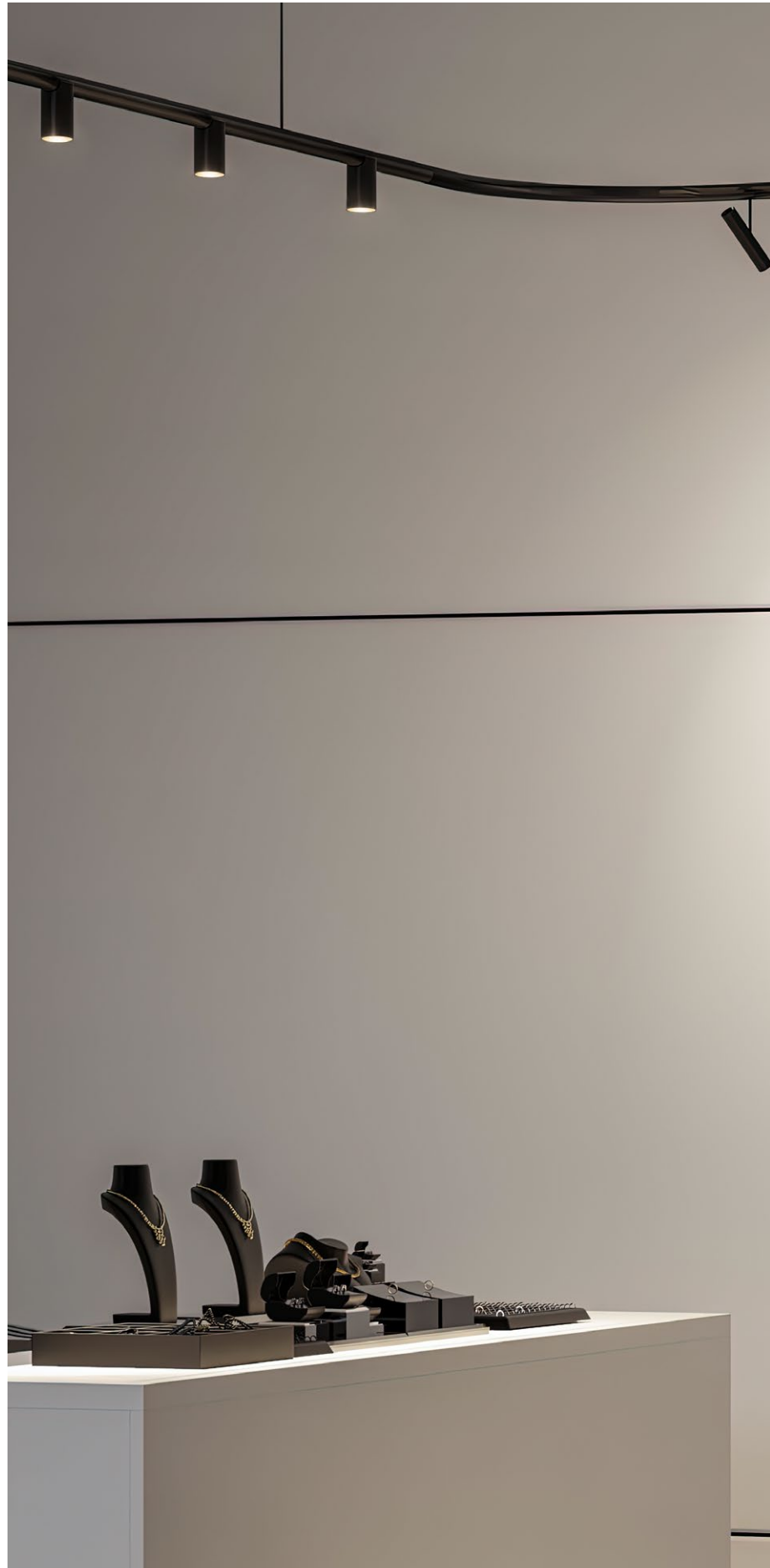



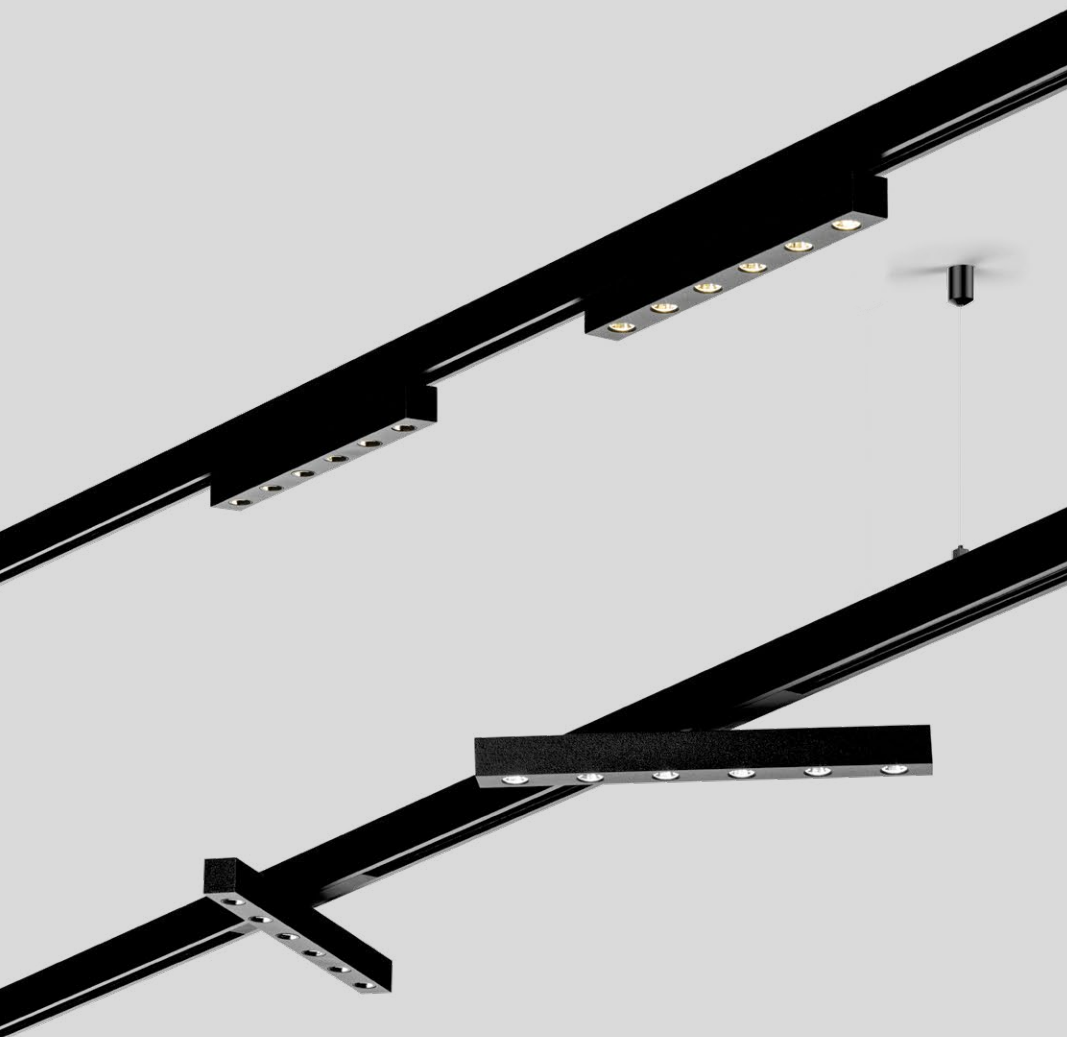

### Quickinfo

2700 K, 3000 K, 4000 K  
 CRI ≥ 90  
 up to 79 lm/W  
 DALI-2

### Type

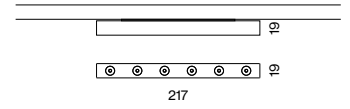

### Colours



### Light distributions



DESIGN  
 AWARD  
 2023

# GIRA

decorative inset 10



360°  
 rotatable



wallwasher  
 floor

## Order options

### COLOUR TEMPERATURE

2700 K	4
3000 K	5
4000 K	6

### CONTROL

DALI-2	
--------	--

### MATERIAL COLOUR

<input type="radio"/> traffic white RAL 9016	7
<input checked="" type="radio"/> jet black RAL 9005	8



### BEAM ANGLE

medium 20°	M
flood 40°	F

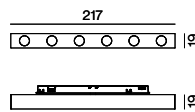
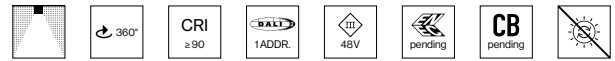
## GIRA





### DOWNLIGHT ROTATABLE

INSET POWER	COLOUR TEMP.	LUMINOUS FLUX	ORDER CODE
19 W	2700 K	1350 lm	0 3 0 - 6 4 1 0 :: 3  
	3000 K	1400 lm	
	4000 K	1450 lm	

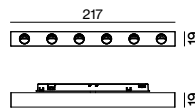
## GIRA wallwasher floor



### WALLWASHER FLOOR ROTATABLE

INSET POWER	COLOUR TEMP.	LUMINOUS FLUX	ORDER CODE
11 W	2700 K	730 lm	0 3 0 - 6 4 3 0 :: 3   W
	3000 K	770 lm	
	4000 K	800 lm	

**INSET POWER** is the current consumption excluding any ballast  
**LUMINOUS FLUX** value calculated for CRI ≥ 90, colour white, medium

**Private Residence**  
Visualisation

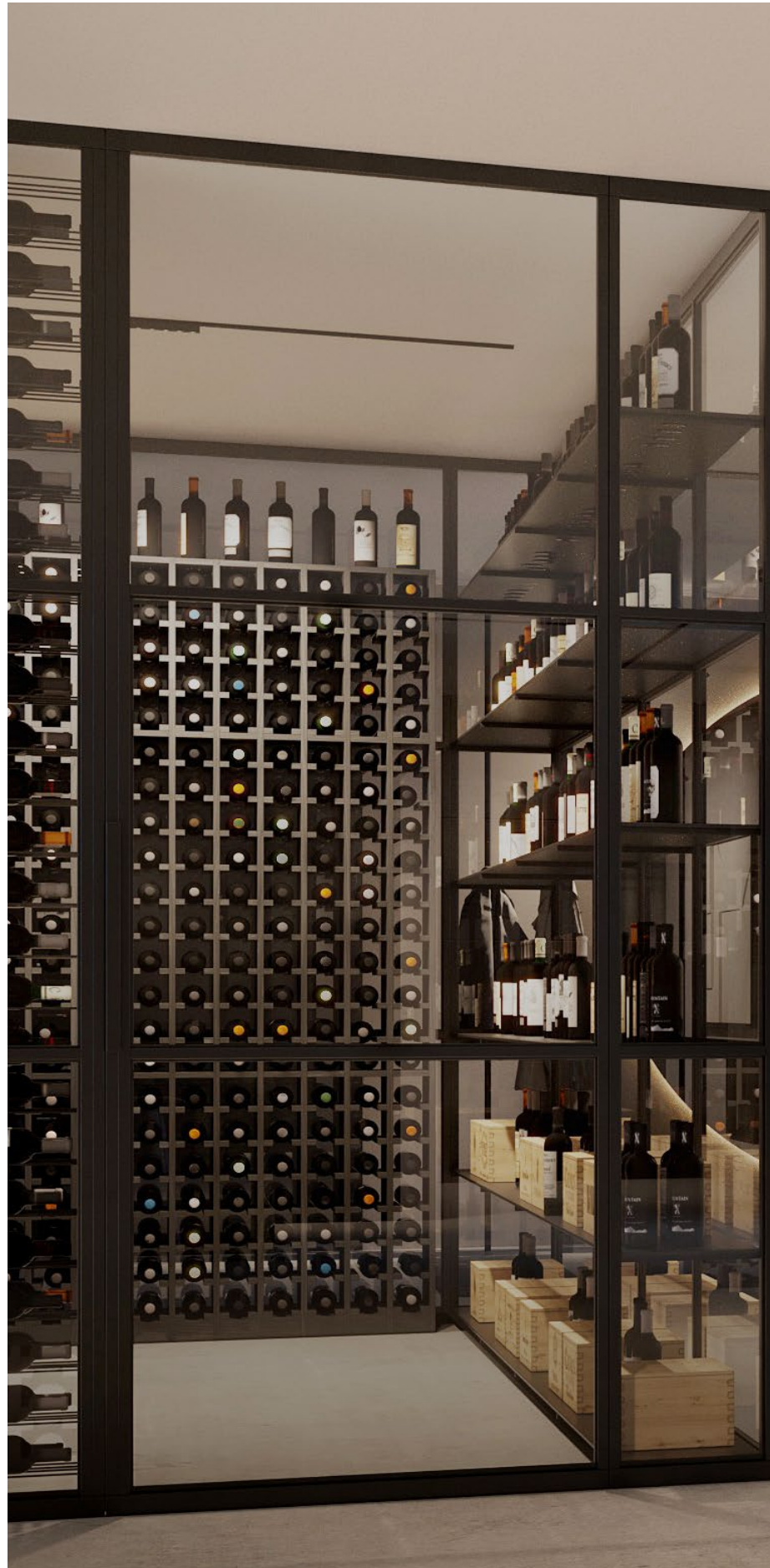





### Quickinfo

2700 K, 3000 K, 4000 K  
 CRI ≥ 90  
 up to 110 lm/W  
 DALI-2

### Types

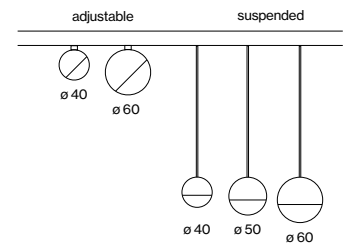

### Colours



### Light distribution



365° rotatable  
 90° tiltable

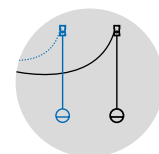

free positioning by  
 cable and hook



high quality  
 glass lens



**NOBA**

decorative inset 10



## Order options

### COLOUR TEMPERATURE

2700 K	4
3000 K	5
4000 K	6

### CONTROL

DALI-2	
--------	--

### MATERIAL COLOUR

○ traffic white RAL 9016	7
● jet black RAL 9005	8
● brushed aluminium	6
● chrome	4

### MATERIAL COLOUR

#### ACCESSORIES

○ traffic white RAL 9016	7
● jet black RAL 9005	8

### BEAM ANGLE

direct 80°	
------------	--

## Options on request

### MATERIAL COLOUR

● gun metal	
● brushed brass	
● rose gold	

## NOBA 40

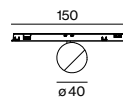

### SPOTLIGHT ADJUSTABLE

INSET POWER	COLOUR TEMP.	LUMINOUS FLUX	ORDER CODE
4.5 W	2700 K	465lm	0 30-6 800 :: 3
	3000 K	480lm	
	4000 K	500lm	

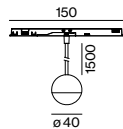

### DOWNLIGHT SUSPENDED

INSET POWER	COLOUR TEMP.	LUMINOUS FLUX	ORDER CODE
4.5 W	2700 K	465lm	0 30-6 900 :: 3
	3000 K	480lm	
	4000 K	500lm	

## NOBA 50

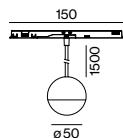

### DOWNLIGHT SUSPENDED

INSET POWER	COLOUR TEMP.	LUMINOUS FLUX	ORDER CODE
9 W	2700 K	695lm	0 30-6 910 :: 3
	3000 K	725lm	
	4000 K	760lm	

## NOBA 60

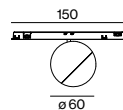

### SPOTLIGHT ADJUSTABLE

INSET POWER	COLOUR TEMP.	LUMINOUS FLUX	ORDER CODE
10 W	2700 K	715lm	0 30-6 820 :: 3
	3000 K	745lm	
	4000 K	780lm	

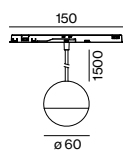

### DOWNLIGHT SUSPENDED

INSET POWER	COLOUR TEMP.	LUMINOUS FLUX	ORDER CODE
10 W	2700 K	715lm	0 30-6 920 :: 3
	3000 K	745lm	
	4000 K	780lm	

## Mounting accessories



### HOOK ceiling mounted

TYPE	Ø-H (mm)	ORDER CODE
hook	16-30	0 30-1 000 0 1

**INSET POWER** is the current consumption excluding any ballast  
**LUMINOUS FLUX** value calculated for CRI≥90, colour white

**Private Residence**  
Visualisation





# Perfect allrounder



## TUBO/SETA 60 CONEX system

**EN** TUBO and SETA make a name for themselves as uniform and minimalist lighting system luminaires that can be flexibly joined by various connecting elements. The luminaires are available for wall and ceiling mounting, as well as in suspended pendant versions. Thanks to their opal cover, the TUBO system luminaire delivers uniform ambient illumination and the characteristic beam angle of up to 340° ensures a soft ceiling illumination that helps build a pleasant room atmosphere. SETA system luminaire's reflectors are particularly noteworthy and have been optimised for office spaces and designed for working at screens. The indirect light component creates a pleasant, homogeneous ceiling illumination for every work area. The CONEX connector (patent pending) grants the system a high degree of flexibility. As a mechanical and electrical L-, T-, and X-shaped connecting element, it allows implementation of geometric shapes over several levels.

**FR** Les systèmes d'éclairage TUBO & SETA se distinguent tout particulièrement pour leur éclairage homogène et leur forme minimaliste. Ils peuvent être juxtaposés en toute flexibilité grâce à différents éléments de raccordement. Ces luminaires s'utilisent aussi bien suspendus qu'en surface sur murs et plafonds. Grâce à son diffuseur opale, le système TUBO crée un éclairage de base homogène et grâce à son rayonnement caractéristique à 340°, il permet d'illuminer le plafond de manière douce, ce qui contribue à une atmosphère agréable dans la pièce. Les réflecteurs du système d'éclairage SETA optimisés pour les bureaux et conçus tout spécialement pour le travail sur écran, méritent une mention particulière. Avec la partie indirecte intégrée, l'éclairage du plafond est homogène et l'ambiance qui en découle est particulièrement agréable et propice au travail. Le connecteur CONEX, en passe d'être breveté, confère une grande flexibilité au système. Cet élément de connexion mécanique et électrique en forme de L, T et X, permet de réaliser des formes géométriques sur plusieurs plans.

### Type



60

### Mountings

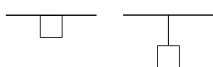

surface

suspended

### System configurations



linear

L

T

X

### Light distributions

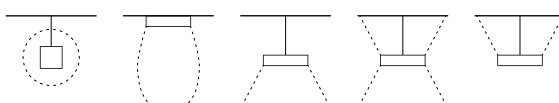

opal

reflector  
(UGR ≤ 19)

direct

direct  
indirect

indirect

## Connector CONEX

**EN** The patent pending CONEX connector system for the TUBO 60 system now offers even more design freedom. With the flexible lighting system, geometric shapes or exciting light sculptures can be created. Thanks to the mechanical and electrical connectors in L, T and X shapes, a visually uniform lighting system is created. In combination with the SETA system, various areas of application are possible - whether as corridor, office luminaire or visual guidance system.

**FR** Le système d'assemblage CONEX pour le système TUBO 60, en passe d'être breveté, offre désormais encore plus de liberté lors de la conception. Ce système d'éclairage flexible permet de créer des formes géométriques ou des sculptures lumineuses fascinantes. Les éléments de connexion mécaniques et électriques en forme de L, T et X, permettent d'obtenir un système d'éclairage visuellement homogène. En combinaison avec le système SETA, différents domaines d'application s'ouvrent à vous - que ce soit pour l'éclairage de couloirs, de bureaux ou comme système de repérage visuel.

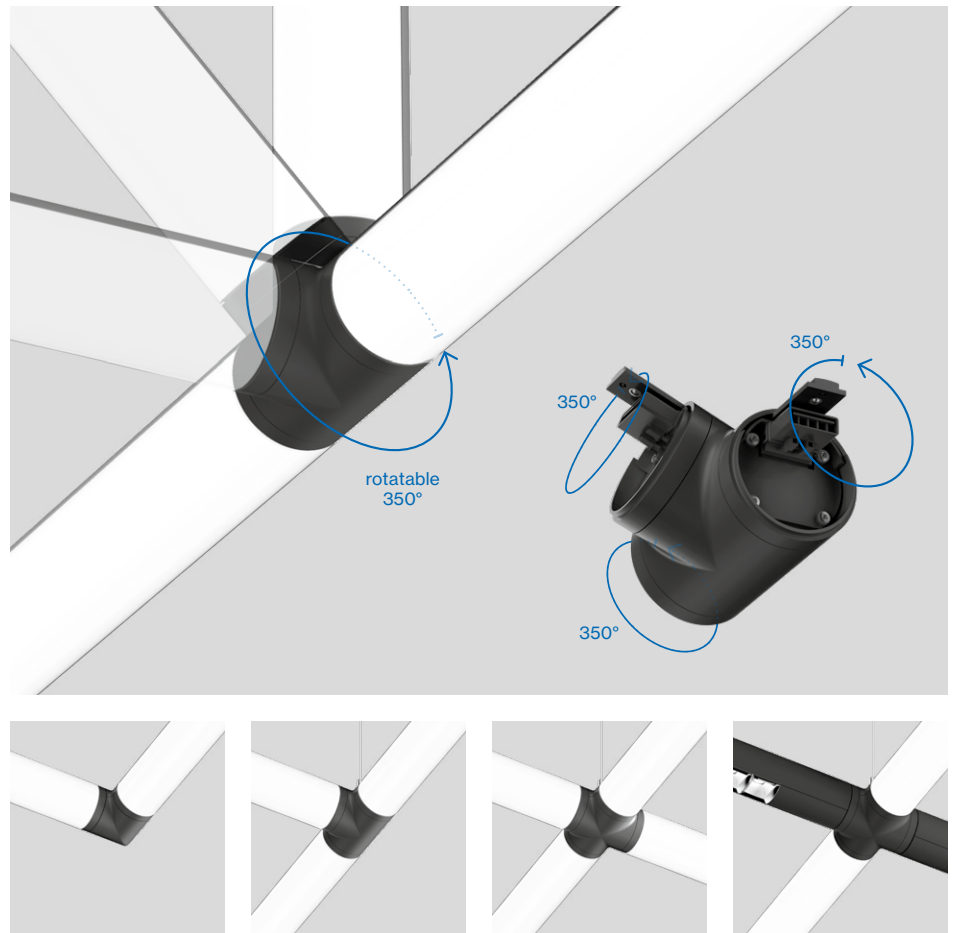

## Easy mounting

**EN** CONEX system luminaires are electrically and mechanically connected by a simple plug-in connection. This makes the installation of a complex lighting system simple, quick, and straightforward.

**FR** Les systèmes de luminaire CONEX sont reliés électriquement et mécaniquement par une simple connexion enfichable. Ainsi, même les systèmes d'éclairage les plus complexes peuvent être montés très simplement, rapidement et avec une facilité déconcertante.

## 340° light distribution

**EN** With its 340° beam pattern and opal cover, TUBO System delivers homogeneous illumination as well as slight ceiling brightening. This makes the system luminaire perfect for places where pleasant ambient lighting is desired, such as reception areas, corridors, or foyers.

**FR** Grâce à son rayonnement caractéristique de 340° et à son diffuseur opale, le système TUBO permet d'obtenir un éclairage homogène et une légère illumination du plafond. Ce système d'éclairage est donc parfaitement adapté aux lieux nécessitant un éclairage de base agréable, comme les zones d'accueil, les couloirs ou les halls d'entrée.

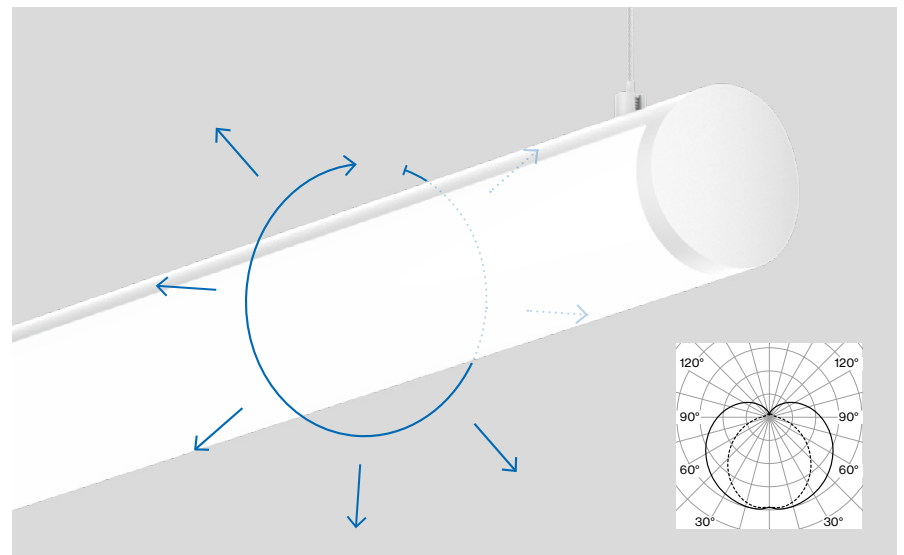



## Work-friendly light

**EN** As an office luminaire, SETA guarantees illumination that is compliant with workplace standards (up to  $UGR \leq 16$ ). Custom glare-free reflectors and the selected use of blind covers direct the light precisely to the work surface and reduce reflections. The direct/indirect version comes with special lens technology that distributes the indirect light component homogeneously and broadly towards the ceiling.

**FR** Conforme aux normes en vigueur, SETA s'utilise pour l'éclairage des postes de travail dans les bureaux (jusqu'à  $UGR \leq 16$ ). Dotés de réflecteurs à protection spéciale anti-éblouissement et de diffuseurs, ces luminaires orientent la lumière avec précision vers la surface de travail, réduisant systématiquement tout reflet au minimum. Sur la variante directe/indirecte, la part de lumière indirecte à large diffusion est distribuée de façon homogène sur le plafond.

## Advanced sensor technology

**EN** Special sensors expand the product family SETA with smart lighting control and collection of insightful data. The ESSENTIAL sensor enables dynamic adjustment of the lighting to ambient brightness and room activity. The SENSE version also measures values such as temperature, air quality, humidity and noise level. These data not only provide important insights into the ambient conditions and use of rooms, but also support energy savings in the long term.

**FR** La famille de produits SETA s'étend grâce à des capteurs spéciaux avec commande intelligente de l'éclairage. Le capteur ESSENTIAL permet d'adapter l'éclairage de façon dynamique en fonction de la luminosité ambiante et de l'activité de la pièce. Le capteur SENSE mesure des valeurs telles que la température, la qualité de l'air, l'humidité et le niveau sonore. Ces données fournissent non seulement des informations importantes sur les conditions ambiantes et l'utilisation des locaux, mais favorisent également les économies d'énergie à long terme.

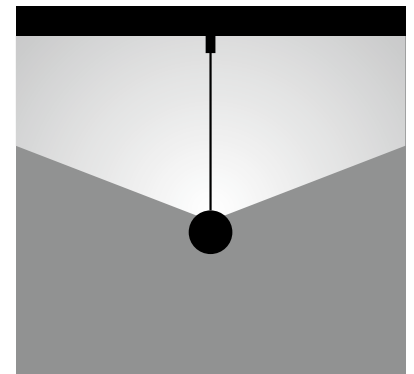

## Indirect version

**EN** SETA indirect stands for the minimalist design of the product family and expands it with an indirect luminaire that provides homogeneous ceiling lighting. This creates a pleasant room feeling and the possibility to illuminate ceiling patterns harmoniously.

**FR** Avec son design minimaliste, le module SETA indirect élargit la famille de produits en proposant un luminaire à éclairage indirect permettant d'illuminer le plafond de manière homogène. Il en résulte une agréable sensation d'espace tout en permettant d'éclairer harmonieusement des motifs de plafond.



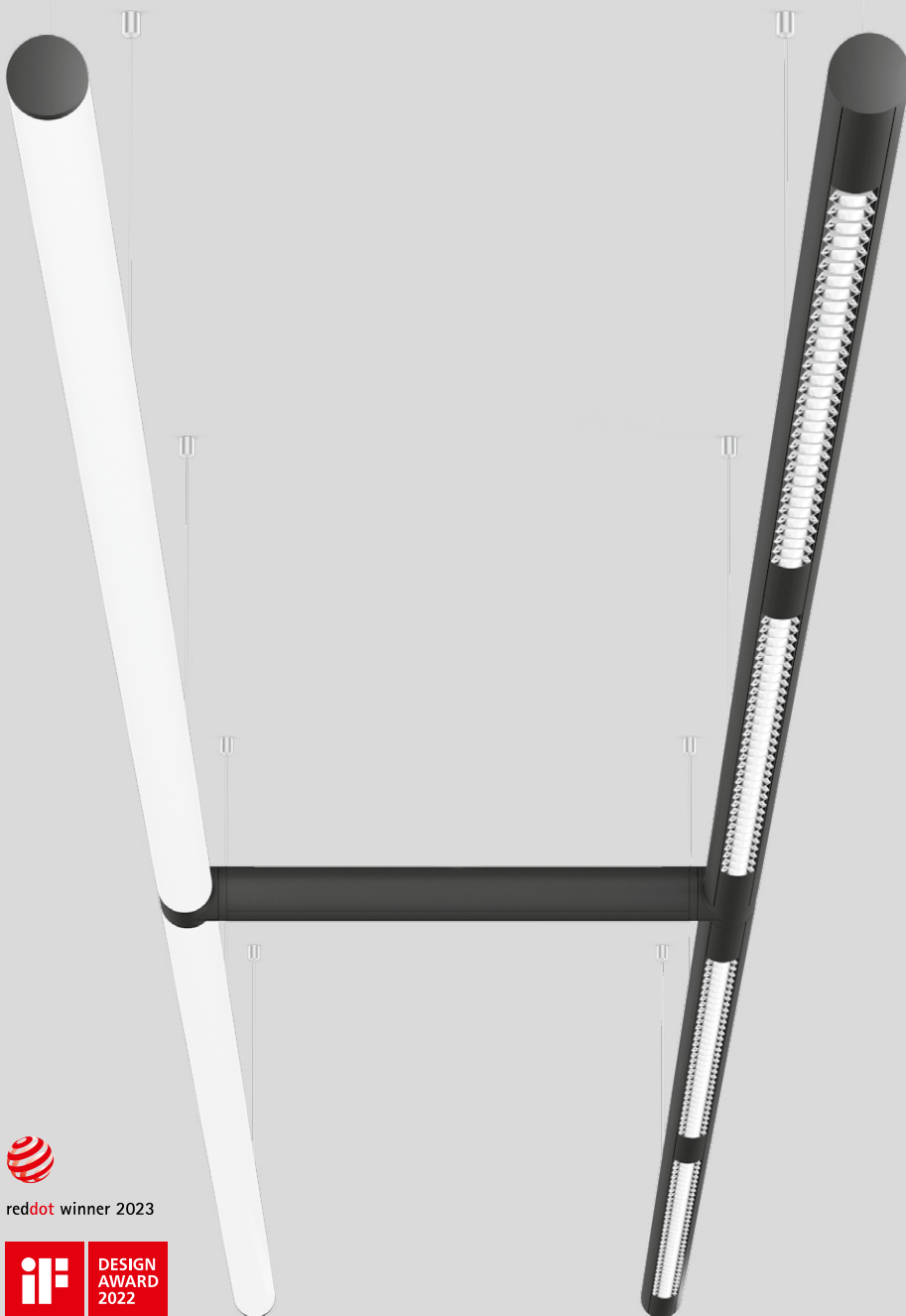

reddot winner 2023



## TUBO/SETA 60 CONEX system

surface / suspended

**EN** Cylindrical lighting system in aluminium; powder coated; ceiling surface mounting or suspended mounting; height adjustment without tools; with transparent feeder cable; electrical connection of the luminaires via plug/socket system; optionally connectors (L-, T- or X-shape); luminaire connection rotatable around its own axis, which means that any spatial angle can be realized; optionally cylindrical HPO (High Performance Opal) cover or high gloss reflector with faceted design; light control via high quality lens system for homogeneous illumination (HPO); direct, indirect or direct / indirect light distribution (reflector); indirect light component with integrated PCBs and high quality lens system for homog. ceiling illumination, separately controllable; energy-eff. LEDs - very good colour rendering

**FR** Système d'éclairage cylindrique en aluminium ; thermolaquée ; applique plafond ou montage suspendu ; réglage en hauteur sans outil ; conduit d'alimentation transparent inclus ; liaison électrique des lampes par système de prise/fiche ; connecteur en option (en L, T ou X) ; le raccord du luminaire peut pivoter sur son propre axe offrant ainsi une palette infinie de configurations d'angle ; au choix, cache cylindr. HPO (High Performance Opal) ou réflecteur brillant avec visuel à facettes ; lumière orientée au moyen d'une optique à lentilles de haute qualité pour un éclairage homogène (HPO) ; caractéristique de rayonnement direct, indirect ou direct / indirect (réflecteur) ; proportion de lumière indir. avec platines propres + optique à lentille pour illum. de plafond homog., commande séparée ; LED à haut rend. éner. - excellent rendu coul.

### Quickinfo

3000K, 4000K  
 CRI ≥ 80, 3 SDCM  
 UGR ≤ 19 / 65° ≤ 3000 cd/m<sup>2</sup>  
 opal up to 3230 lm/m  
 up to 160 lm/W  
 L90 @ 50000h  
 DALI-2  
 opal, reflector (UGR ≤ 19)

### Types

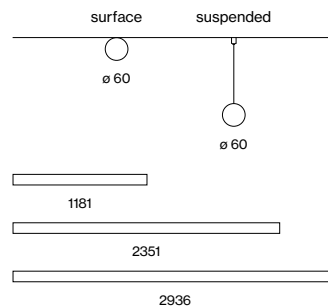

CONEX connector

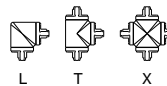

### Colours



### Light distributions

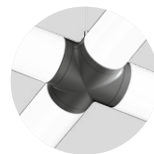
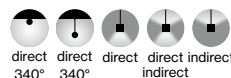

connector  
CONEX

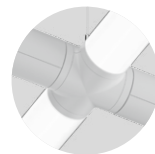

combinable with  
TUBO & SETA



up to 160 lm/W  
(high efficiency)

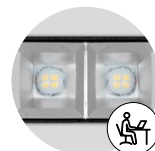

DIN EN 12464-1  
UGR ≤ 19

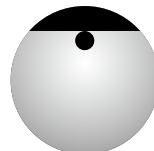

TUBO: direct  
340° uniform  
illumination

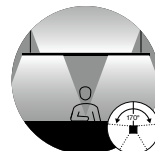



SETA: direct  
and 170° indirect  
illumination



## Order options

### THROUGH WIRE TYPE

standard 	2
CONEX L/T/X 	3

between two CONEX connectors  
one CONEX luminaire or blind channel  
is needed

### COLOUR TEMPERATURE

3000K	5
4000K	6

### CONTROL

DALI-2

### MATERIAL COLOUR

○ pure white RAL 9010	7
● jet black RAL 9005	8

### REFLECTOR COLOUR



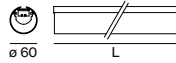





✓ chrome	R
● dark chrome	B



## TUBO 60 surface/suspended



### OPAL 340° DIRECT









SYS. POWER	COLOUR TEMP.	LUM. FLUX	L (mm)	ORDER CODE
33 W	3000K	3560lm	1181	0 5 8 - 3 0  4  3  0
	4000K	3760lm		
66 W	3000K	7110lm	2351	0 5 8 - 3 0  8  3  0
	4000K	7530lm		
82 W	3000K	8890lm	2936	0 5 8 - 3 0  9  3  0
	4000K	9410lm		



## SETA 60 surface/suspended











### REFLECTOR DIRECT

SYS. POWER	COLOUR TEMP.	LUM. FLUX	L (mm)	ORDER CODE
19.3 W	3000K	2670lm	1181	0 5 8 - 4 0  4  3  ■
	4000K	3040lm		
45 W	3000K	6240lm	2351	0 5 8 - 4 0  8  3  ■
	4000K	7100lm		
58 W	3000K	8020lm	2936	0 5 8 - 4 0  9  3  ■
	4000K	9130lm		







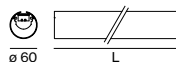



### REFLECTOR DIRECT/INDIRECT

SYS. POWER	COLOUR TEMP.	LUM. FLUX	L (mm)	ORDER CODE
45 W (2×DALI)	3000K	↓ 2670/± 3530lm	1181	0 5 8 - 4 1  4  3  ■
	4000K	↓ 3040/± 4010lm		
92 W (2×DALI)	3000K	↓ 6240/± 7050lm	2351	0 5 8 - 4 1  8  3  ■
	4000K	↓ 7100/± 8030lm		
116 W (2×DALI)	3000K	↓ 8020/± 8820lm	2936	0 5 8 - 4 1  9  3  ■
	4000K	↓ 9130/± 10000lm		



















### INDIRECT

SYS. POWER	COLOUR TEMP.	LUM. FLUX	L (mm)	ORDER CODE
26.1 W	3000K	3530lm	1181	0 5 8 - 4 2  4  3  ■
	4000K	4010lm		
52 W	3000K	7050lm	2351	0 5 8 - 4 2  8  3  ■
	4000K	8030lm		
65 W	3000K	8820lm	2936	0 5 8 - 4 2  9  3  ■
	4000K	10000lm		



### BLIND CHANNEL incl. through wiring

L (mm)	ORDER CODE
585	0 5 8 - 4 9  2  0  3  ■
1185	0 5 8 - 4 9  4  0  3  ■
2351	0 5 8 - 4 9  8  0  3  ■
2936	0 5 8 - 4 9  9  0  3  ■

## Accessories

see next page

**Configuration example**

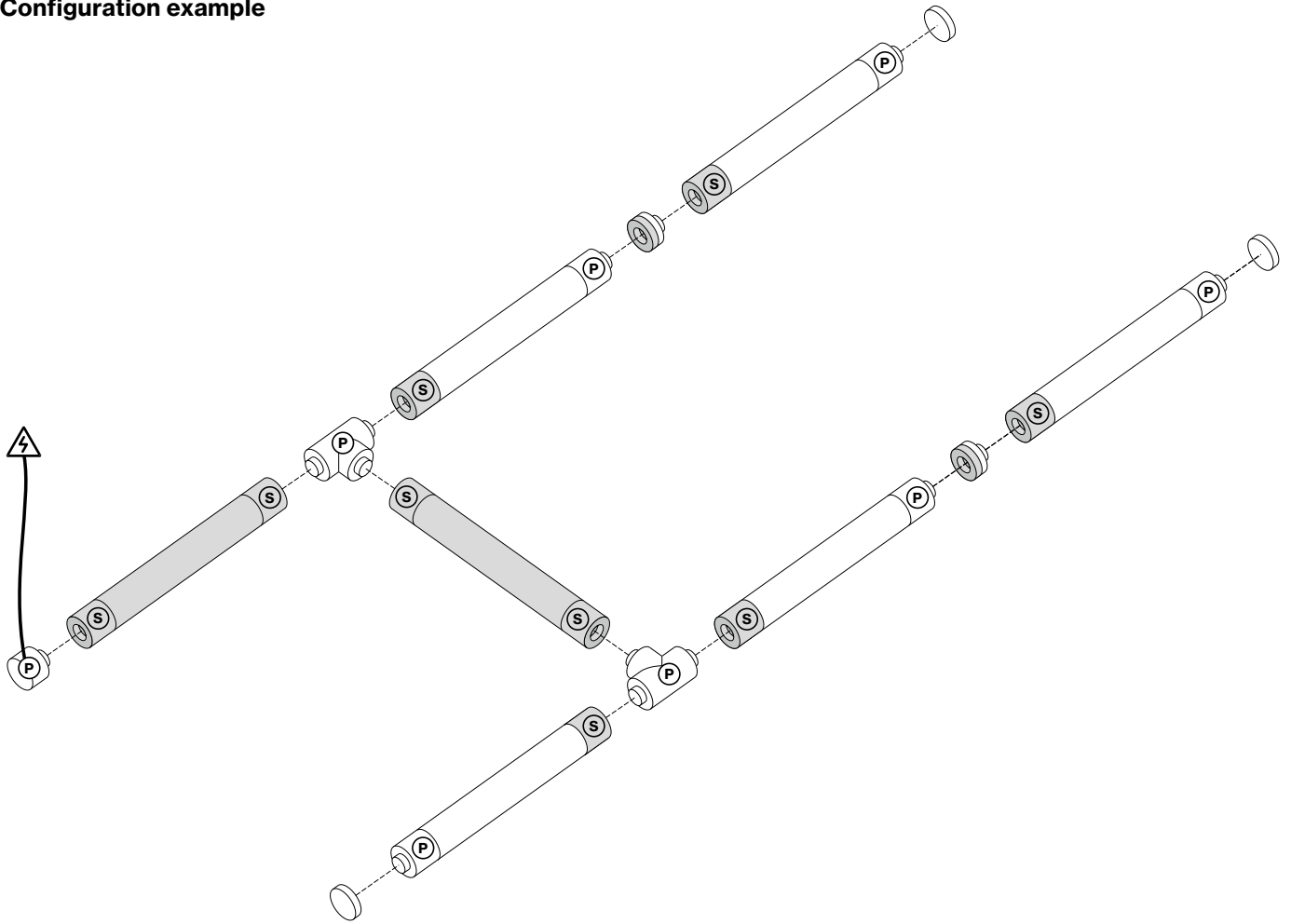

**Components**

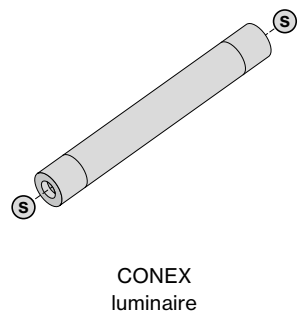
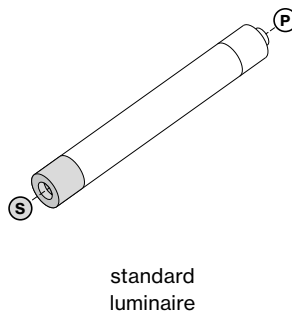
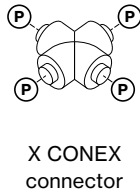
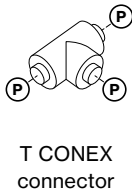
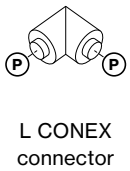
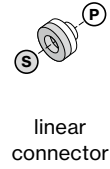
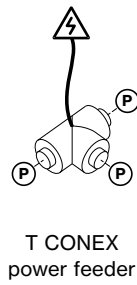
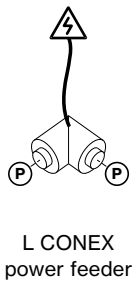
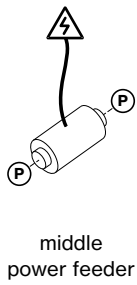
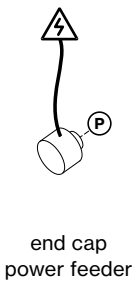

## Order options

MATERIAL COLOUR	
○ pure white RAL 9010	7
● jet black RAL 9005	8

MATERIAL COLOUR CABLE SUSPENSION	
↗ chrome	0
● black	8



## Accessories

### END CAP

TYPE	ORDER CODE
end cap	058-301001

### POWER FEEDER SURFACE

TYPE	ORDER CODE
end cap power feeder	058-301021
middle power feeder*	058-301121

\*incl. feeder cable 5×1.5mm<sup>2</sup>

### POWER FEEDER SUSPENDED incl. feeder cable 5×1.5mm<sup>2</sup>

TYPE	L (mm)	ORDER CODE
end cap power feeder	1500	058-301041
middle power feeder*	1500	058-301131
L CONEX power feeder**	1500	058-301873
T CONEX power feeder**	1500	058-301883

\*order cable suspension separately; \*\*order CONEX cable suspension separately

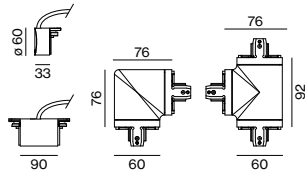

### LINEAR CONNECTOR

TYPE	ORDER CODE
linear connector mechanical	058-301311
linear connector mechanical & electrical	058-301312

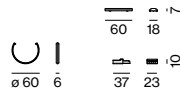

### LINEAR CONNECTOR SUSPENDED incl. cable suspension 1500mm

TYPE	L (mm)	ORDER CODE
linear connector mechanical	1500	058-301321
linear connector mech. & electr.	1500	058-301322

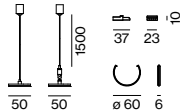

### CONEX CONNECTOR

TYPE	ORDER CODE
L CONEX connector mech. & electr.	058-301872
T CONEX connector mech. & electr.	058-301882
X CONEX connector mech. & electr.	058-301892

order CONEX cable suspension separately

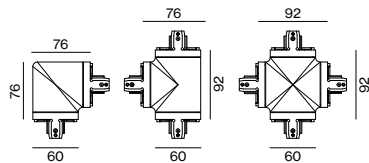

### MOUNTING SET

TYPE	L (mm)	ORDER CODE
ceiling mounting set	75	058-301411
cable suspension	1500	058-301421
cable suspension angular max. 60°	1500	058-301431
CONEX cable suspension	1500	058-301811

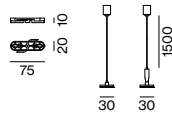

### CANOPY

TYPE	Ø-H (mm)	ORDER CODE
canopy	90-22	005-260003

for electrical system configuration see luminaire data sheet at xal.com

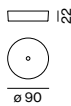

### SENSOR DALI-2

TYPE	ORDER CODE
ESSENTIAL (brightness & presence)	058-301911
SENSE (brightness, presence, temperature, sound pressure, humidity, CO <sub>2</sub> )	058-301921

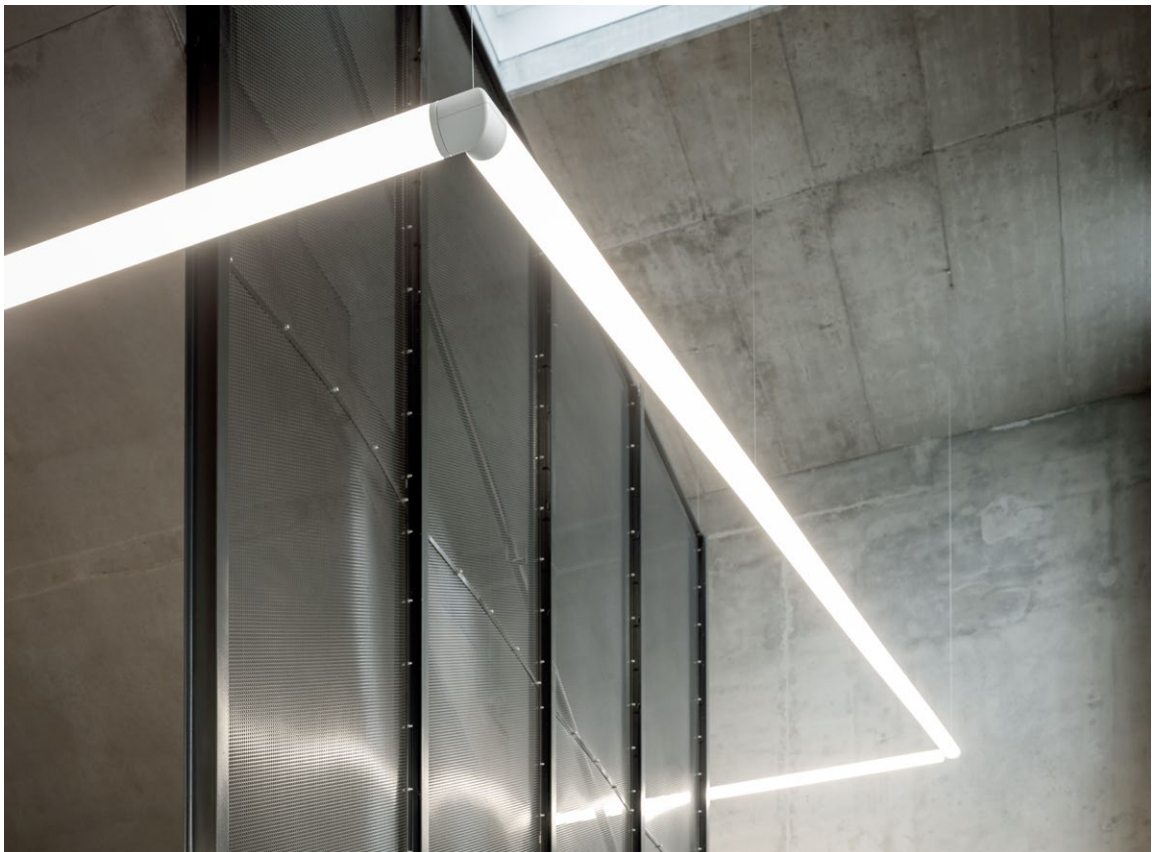
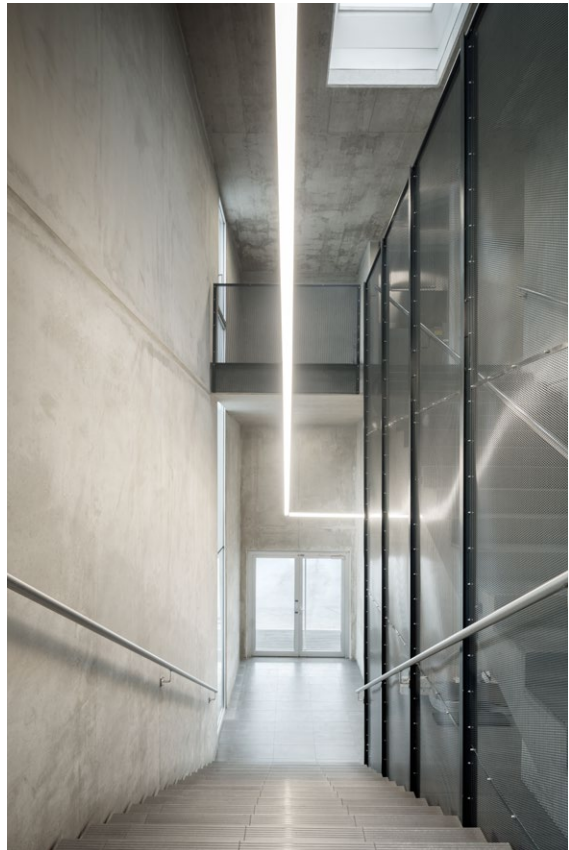

**XAL Headquarters** Graz, AT



# Discreet perfection



# MITA

**EN** MITA combines high performance with a slim design language and its wide range of applications is impressive. The product family is available as recessed or surface-mounted luminaire in a round or square design as well as suspended version. All the versions of the luminaire have special reflectors for the best screen-compatible work lighting – perfect for use in offices or meeting rooms. The product family is available in the light colours 3000 K, 4000 K, or Tunable White. Optionally, the luminaire can be equipped with a presence and brightness sensor.

**FR** MITA allie performance et langage des formes et séduit également par ses multiples utilisations possibles. La famille de produits est proposée en version luminaire à encastrer ou apparent, dans un format rond ou carré, ainsi qu'en version suspendue. Quelle que soit la finition choisie, le luminaire dispose de réflecteurs spéciaux pour un éclairage de travail optimal et adapté aux écrans - idéal dans les bureaux et les salles de réunion. La famille de produits est proposée dans les températures de lumière 3000 K, 4000 K ou en option Tunable White. En option, le luminaire peut être équipé d'un capteur de présence et de luminosité.

## Types

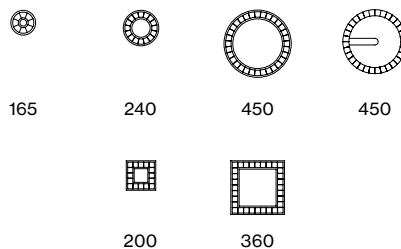

## Mountings

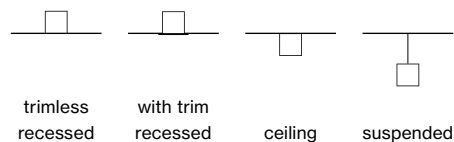

## Light distributions

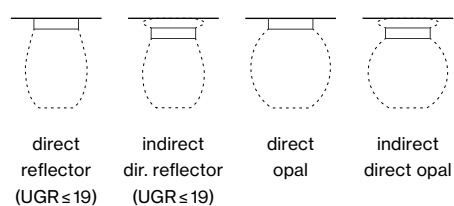



## Variety

**EN** MITA is characterised by an elegant design language with maximum efficiency and versatile application possibilities. The MITA product family is available as a recessed or surface-mounted luminaire in round and square versions, as well as a suspended variant. For a uniform ceiling appearance, the cover can simply be attached magnetically and is available as a reflector or opal cover.

**FR** MITA marie un design des plus élégants à une efficacité maximale et séduit également par ses multiples utilisations possibles. La famille de produits MITA est proposée en version luminaire à encastrer ou apparent, dans un format rond ou carré, ainsi qu'en version suspendue. Pour un aspect uniforme du plafond, le diffuseur, qui se fixe facilement par aimant, est disponible en version réflecteur ou diffuseur opale.

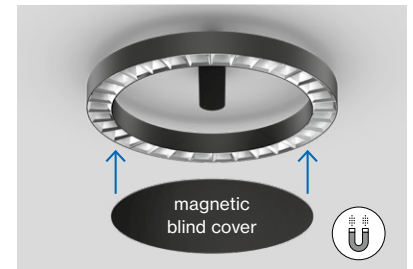



## Advanced sensor technology

**EN** Special sensors expand the MITA product family with smart lighting control and collection of insightful data. The ESSENTIAL sensor enables dynamic adjustment of the lighting to ambient brightness and room activity. The SENSE sensor also measures values such as temperature, air quality, humidity and noise level. These data not only provide important insights into the ambient conditions and use of rooms, but also support energy savings in the long term.

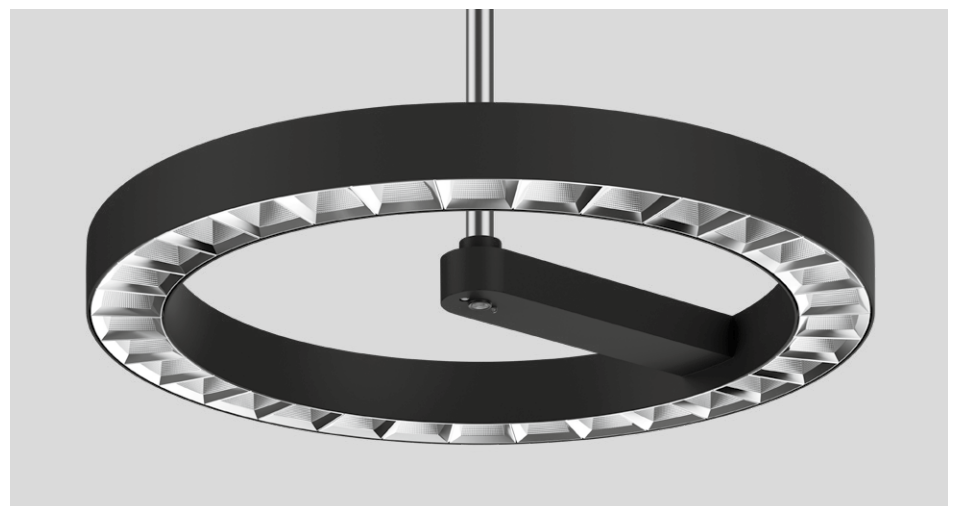





**FR** Des capteurs spéciaux élargissent la gamme de produits MITA pour une commande intelligente de l'éclairage. Le capteur ESSENTIAL permet d'adapter l'éclairage de façon dynamique en fonction de la luminosité ambiante et de l'activité de la pièce. Le capteur SENSE mesure également des valeurs telles que la température, la qualité de l'air, l'humidité et le niveau sonore. Ces données fournissent non seulement des informations importantes sur les conditions ambiantes et l'utilisation des locaux, mais favorisent également les économies d'énergie à long terme.



### ESSENTIAL sensor

-  brightness
-  presence

### SENSE sensor

-  brightness
-  presence
-  temperature
-  humidity
-  sound pressure
-  CO<sub>2</sub>



## Light distribution

**EN** As an office luminaire, MITA guarantees the best possible working light. Special, glare-reduced reflectors direct the light precisely onto the work surface and reduce reflections. The opal cover ensures homogeneous room illumination. With the direct/indirect power version of the suspended luminaire, the indirect light component has a very wide beam and distributes the light evenly across the ceiling. The direct/indirect soft light component of the surface-mounted version produces a gentle and light ceiling illumination, making the luminaire appear to almost float.

**FR** Conçu spécialement pour les bureaux, MITA garantit une excellente lumière de travail. Il est doté de réflecteurs à protection spéciale anti-éblouissement qui dirigent la lumière avec précision sur la surface de travail et réduisent les reflets. Le diffuseur opale permet d'éclairer la pièce de façon homogène. Sur la variante « power » direct/indirect du luminaire suspendu, la part de lumière indirecte à large diffusion est distribuée de façon homogène sur le plafond. La part de lumière directe/indirecte de la variante « soft » apparente crée un éclairage doux et léger du plafond qui semble flotter presque en apesanteur dans l'espace.

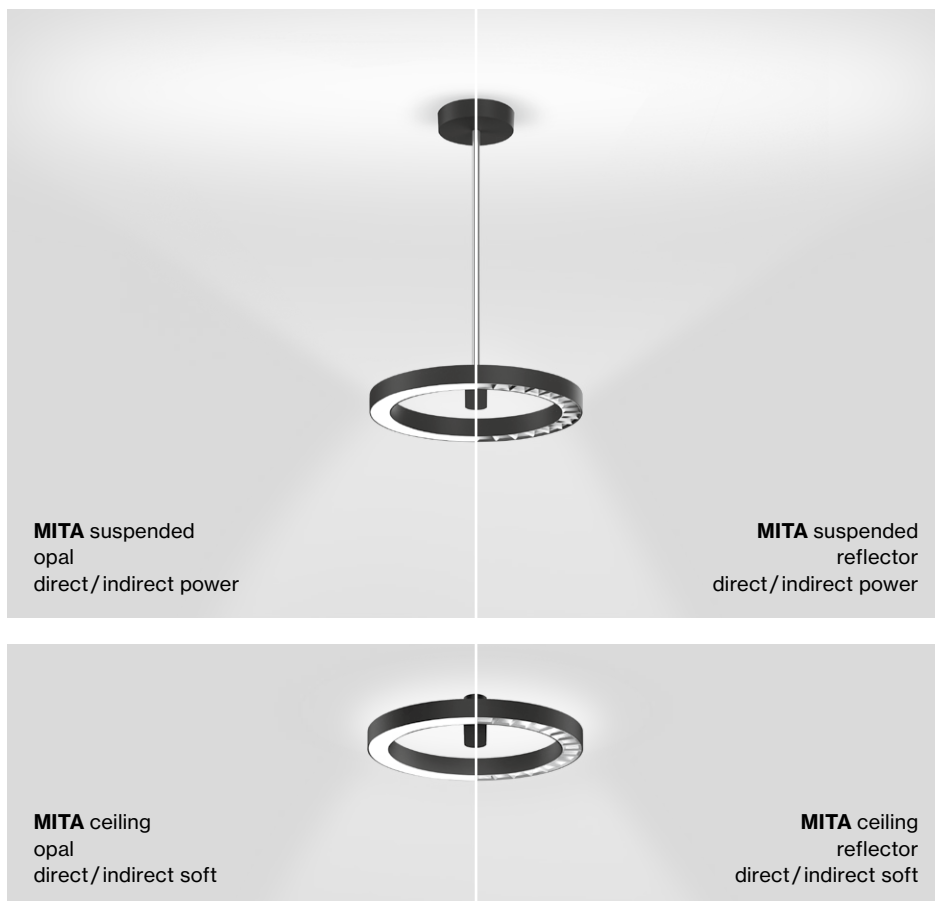

## Discreet accentuation

**EN** MITA sets discreet accents for a pleasant room atmosphere. The product is available in black or white, and with or without a cover. The magnetic cover attaches easily and the indirect component provides gentle and light ceiling brightening.

**FR** MITA ceiling met des touches discrètes dans la pièce pour une atmosphère agréable. Il est disponible en noir ou en blanc et, au choix, avec un cache. Le diffuseur se fixe facilement par aimant. La part de lumière indirecte crée un éclairage doux et léger du plafond qui semble flotter presque en apesanteur dans l'espace.

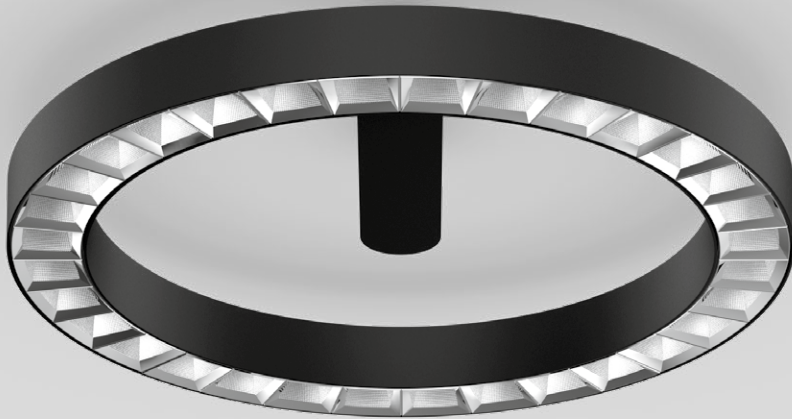

## MITA circle

ceiling

**EN** Ring shaped luminaire housing in die-cast aluminium; extremely slim design; surface powder coated; luminaire housing set away from ceiling; electronic operating unit installed in the surface mounted housing; surface mounted housing aligned from the ring to the center; optional: blind cover to cover the cut-out, held by magnet, available as an accessory; high-gloss reflector with faceted design; HPO (High Performance Opal) cover for uniform illumination; either with direct or direct/indirect light distribution; energy-efficient LEDs with very good colour rendering

**FR** Corps de luminaire en forme d'anneau en fonte d'aluminium injectée; forme extrêmement élançonnée; surface thermolaquée; corps de luminaire écarté du plafond; appareil de comm. électr. monté dans le boîtier appar.; boîtier apparent dépassant au centre de l'anneau; en option: cache, fixé par aimant dans l'encoche intérieure, disponible comme accessoire; réflecteur ultra-brillant avec optique à facettes; cache HPO (High Performance Opal) pour éclairage homogène; au choix avec caractéristique de rayonnement direct ou direct/indirect; LED économes en énergie à restitution de couleur élevée

### Quickinfo

3000 K, 4000 K  
 CRI  $\geq$  80, 3 SDCM  
 UGR  $\leq$  19 /  $65^\circ \leq 1500$  cd/m<sup>2</sup>  
 up to 158 lm/W  
 L90 @ 50 000h  
 DALI-2, DALI-2 sensor  
 reflector (UGR  $\leq$  19), opal

### Types

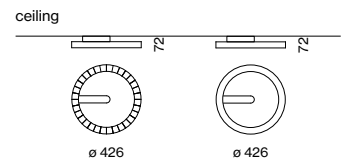

### Colours



### Light distributions

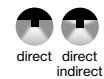

dark chrome  
reflector option



up to 158 lm/W  
(high efficiency)

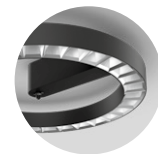

sensor version  
available



version with  
opal cover



magnetic  
blind cover



DIN EN 12464-1  
UGR  $\leq$  19

### Order options

COLOUR TEMPERATURE	
3000K	5
4000K	6

CONTROL	
DALI-2	3
DALI-2 ESSENTIAL sensor (brightness & presence)	B
DALI-2 SENSE sensor (brightness, presence, temp., sound pressure, humidity, CO <sub>2</sub> )	P

MATERIAL COLOUR	
○ traffic white RAL 9016	7
● jet black RAL 9005	8

REFLECTOR COLOUR	
✓ chrome	R
● dark chrome	B

LIGHT OPTIC COVER	
reflector (UGR ≤ 19)	
opal	

### Options on request

COLOUR RENDERING INDEX	
CRI ≥ 90	

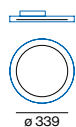
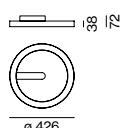
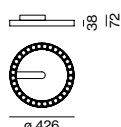
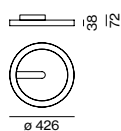
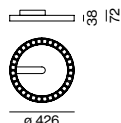

### MITA circle 450 ceiling



#### REFLECTOR DIRECT

SYSTEM POWER	COLOUR TEMP.	LUMINOUS FLUX	ORDER CODE
30 W	3000K	4210lm	074-75111
	4000K	4790lm	
40 W	3000K	5470lm	074-75211
	4000K	6230lm	

#### OPAL DIRECT

SYSTEM POWER	COLOUR TEMP.	LUMINOUS FLUX	ORDER CODE
24.9 W	3000K	2770lm	074-75111
	4000K	3150lm	



#### REFLECTOR DIRECT / INDIRECT SOFT

SYSTEM POWER	COLOUR TEMP.	LUMINOUS FLUX	ORDER CODE
30 W	3000K	↓ 4220 / ± 72lm	074-75311
	4000K	↓ 4800 / ± 82lm	
40 W	3000K	↓ 5490 / ± 94lm	074-75611
	4000K	↓ 6240 / ± 107lm	

#### OPAL DIRECT / INDIRECT SOFT

SYSTEM POWER	COLOUR TEMP.	LUMINOUS FLUX	ORDER CODE
24.9 W	3000K	↓ 2700 / ± 136lm	074-75311
	4000K	↓ 3080 / ± 155lm	

### Accessories

#### BLIND COVER

TYPE	ORDER CODE
MITA circle 450 ceiling	074-891162
MITA circle 450 ceiling sensor	074-891163

### Light distribution

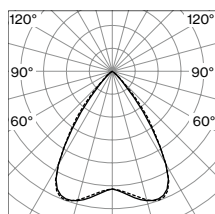

reflector (UGR ≤ 19)  
direct

LUMINOUS FLUX value calculated for  
CRI ≥ 80, colour white, reflector chrome

**Meeting room**  
Visualisation





**Hallway**  
Visualisation







## MITA circle

suspended

**EN** Ring shaped luminaire housing in die-cast aluminium; extremely slim design; surface powder coated; suspended; with height adjustable rod suspension (chrome), feed in rod; electronic operating unit installed in the canopy; optional: blind cover to cover the cut-out, held by magnet, available as an accessory; high gloss reflector with faceted design; HPO (High Performance Opal) cover for uniform illumination; either with direct or direct/indirect light distribution; energy-efficient LEDs with very good colour rendering

**FR** Corps de luminaire en forme d'anneau en fonte d'aluminium injectée; forme extrêmement élancée; surface thermolaquée; suspendu; avec suspension pouvant être raccourcie (chrome), conduit d'alimentation dans le tube de suspension; disp. électronique d'alimentation intégré au cache-piton; en option: cache, fixé par aimant dans l'encoche intérieure, disponible comme accessoire; réflecteur ultra-brillant avec optique à facettes; cache HPO (High Performance Opal) pour éclairage homogène; au choix avec caractéristique de rayonnement direct ou direct/indirect; LED économes en énergie à restitution de couleur élevée

### Quickinfo

3000 K, 4000 K  
 CRI ≥ 80, 3 SDCM  
 UGR ≤ 19 / 65° ≤ 1500 cd/m<sup>2</sup>  
 up to 160 lm/W  
 L90 @ 50 000h  
 DALI-2, DALI-2 sensor  
 reflector (UGR ≤ 19), opal

### Types

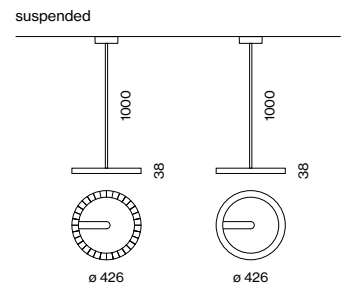

### Colours



### Light distributions

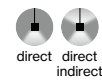

dark chrome  
reflector option



up to 160 lm/W  
(high efficiency)

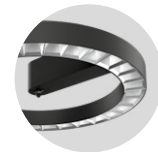

sensor version  
available



version with  
opal cover



magnetic  
blind cover



DIN EN 12464-1  
UGR ≤ 19



## Order options

### SUSPENSION

rod 1000 mm

### COLOUR TEMPERATURE

3000K	5
4000K	6

### CONTROL

DALI-2	3
DALI-2 ESSENTIAL sensor (brightness & presence)	B
DALI-2 SENSE sensor (brightness, presence, temp., sound pressure, humidity, CO <sub>2</sub> )	P

### MATERIAL COLOUR

○ traffic white RAL 9016	7
● jet black RAL 9005	8

### REFLECTOR COLOUR

↗ chrome	R
● dark chrome	B

### LIGHT OPTIC COVER

reflector (UGR ≤ 19)  
opal

## Options on request

### SUSPENSION

rod 1000 mm white  
rod 1000 mm black

### COLOUR RENDERING INDEX

CRI ≥ 90

### COLOUR TEMPERATURE

tunable white 2700–6500K

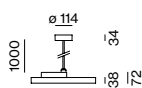
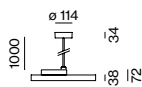
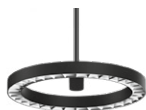

## MITA circle 450 suspended



UGR  
≤ 19

cd/m<sup>2</sup>  
≤ 1500

DALI  
1ADDR.

220-240V

X-PERT

X-PERT

### REFLECTOR DIRECT

SYSTEM POWER	COLOUR TEMP.	LUMINOUS FLUX	ORDER CODE
30W	3000K	4210lm	074-76111
	4000K	4790lm	
41W	3000K	5470lm	074-76211
	4000K	6230lm	

### OPAL DIRECT

SYSTEM POWER	COLOUR TEMP.	LUMINOUS FLUX	ORDER CODE
25.1W	3000K	2770lm	074-76111
	4000K	3060lm	



UGR  
≤ 19

cd/m<sup>2</sup>  
≤ 1500

DALI  
1ADDR.

220-240V

X-PERT

X-PERT

### REFLECTOR DIRECT / INDIRECT POWER

SYSTEM POWER	COLOUR TEMP.	LUMINOUS FLUX	ORDER CODE
58W	3000K	↓ 4030 / ↑ 3780lm	074-76511
	4000K	↓ 4600 / ↑ 4310lm	

### OPAL DIRECT / INDIRECT POWER

SYSTEM POWER	COLOUR TEMP.	LUMINOUS FLUX	ORDER CODE
58W	3000K	↓ 3140 / ↑ 3780lm	074-76511
	4000K	↓ 3570 / ↑ 4310lm	

## Accessories

### BLIND COVER

TYPE	ORDER CODE
MITA circle 450 suspended	074-891162
MITA circle 450 suspended sensor	074-891163

**ALLPLAN Österreich GmbH**  
Graz, AT





# Hidden talent



## SPIO

**EN** Round, recessed SPIO spotlights bring special lighting to your rooms. The luminaire provides an impressive lighting effect, trimless or with a trim. The housing can be painted over, allowing the spotlight to blend seamlessly into the ceiling. The small light aperture of 10 mm makes the SPIO itself appear almost hidden – but the equally effective and calm overall impression is anything but invisible. The round, recessed spotlight is available with beam angles of 35° or 44° and can be rotated 360° in the housing and pivoted 30° in all directions. In addition, SPIO 20 is available with Wallwasher Floor optic, which creates a uniform wall illumination. These different lighting options mean that versatile designs for interiors are possible. SPIO is available in the light colours 2700 K, 3000 K, and 4000 K.

**FR** Les spots encastrés ronds SPIO permettent une mise en lumière idéale de toutes vos pièces. Avec ou sans bord continu, le luminaire assure un effet lumineux impressionnant. Le boîtier peut être facilement peint, ce qui permet au projecteur de se fondre parfaitement dans le décor du plafond. Si la petite ouverture pour la sortie de la lumière de 10 mm est quasi invisible, l'impression générale de quiétude procure un effet maximal. Le spot rond encastré est disponible avec un angle de diffusion de 35° ou 44°. En outre, il peut non seulement pivoter à 360°, mais également être incliné jusqu'à 30° dans toutes les directions. De plus, SPIO 20 est disponible en version lèche-mur Floor, ce qui permet d'obtenir une lumière homogène sur les murs. Il en résulte un aménagement polyvalent de l'espace avec différentes possibilités d'éclairage. SPIO est disponible dans les températures de lumière 2700K, 3000K et 4000K.

### Types



20

60

### Mountings

trimless  
recessedwith trim  
recessed

### Light distributions

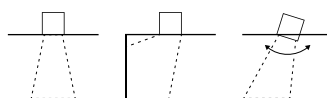

downlight

floor  
wallwasher

spotlight

## High-efficiency lens

**EN** Large light output – almost unnoticed. SPIO has a special LFO lens, which is mounted at an exact distance from the light-emission surface, thus ensuring that no light beam appears on the inner surface of the housing. This reduces the light-emission surface, and SPIO illuminates the room almost unnoticed.

**FR** Un excellent rendu lumineux, sans se faire remarquer. SPIO est équipé d'une lentille LFO spéciale, qui est montée à une distance précise de la surface de sortie de la lumière. Ses dimensions sont spécialement étudiées pour éviter que le rayon lumineux n'apparaisse sur la surface intérieure du boîtier. La surface de sortie de la lumière est ainsi réduite, SPIO éclairant la pièce de manière presque imperceptible.

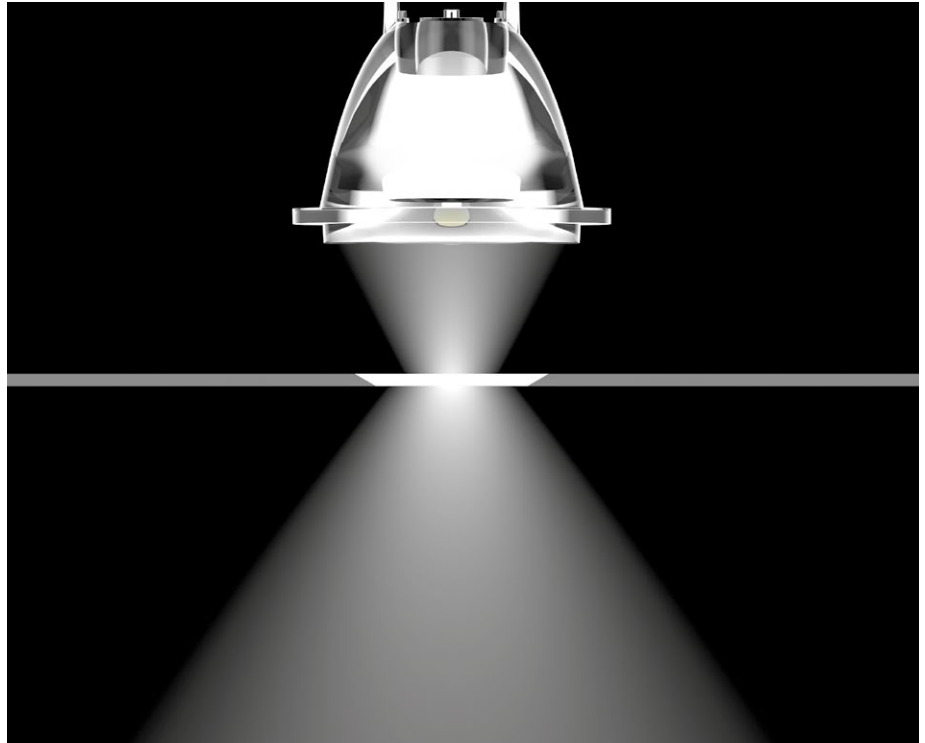

## Homogeneous appearance

**EN** SPIO is the right choice for a uniform ceiling appearance. Thanks to its extremely small light aperture of 10 mm, the recessed spotlight appears almost invisible. The effective lighting is rounded off by its minimalist design language.

**FR** SPIO, le choix idéal pour un plafond harmonieux. Avec son infime ouverture - 10 mm seulement - pour le passage de la lumière, ce spot encastré est quasi-invisible. L'effet lumineux ainsi obtenu est parachevé par sa forme épurée.

## Light distribution

**EN** Despite its small emission surface, the recessed spotlight achieves a beam angle of either 35° or 44°. SPIO 20 is also available with Wallwasher Floor optic, which creates a homogeneous wall brightening effect. SPIO thus provides glare-free light and skilfully stages objects.

**FR** Malgré une surface de sortie réduite, l'angle de rayonnement du spot encastré atteint tout de même les 35° ou 44° au choix. La solution SPIO 20 est en outre disponible en version lèche-mur Floor, qui diffuse une lumière homogène sur les murs. SPIO réduit l'éblouissement au minimum pour mettre habilement en valeur les différents objets.

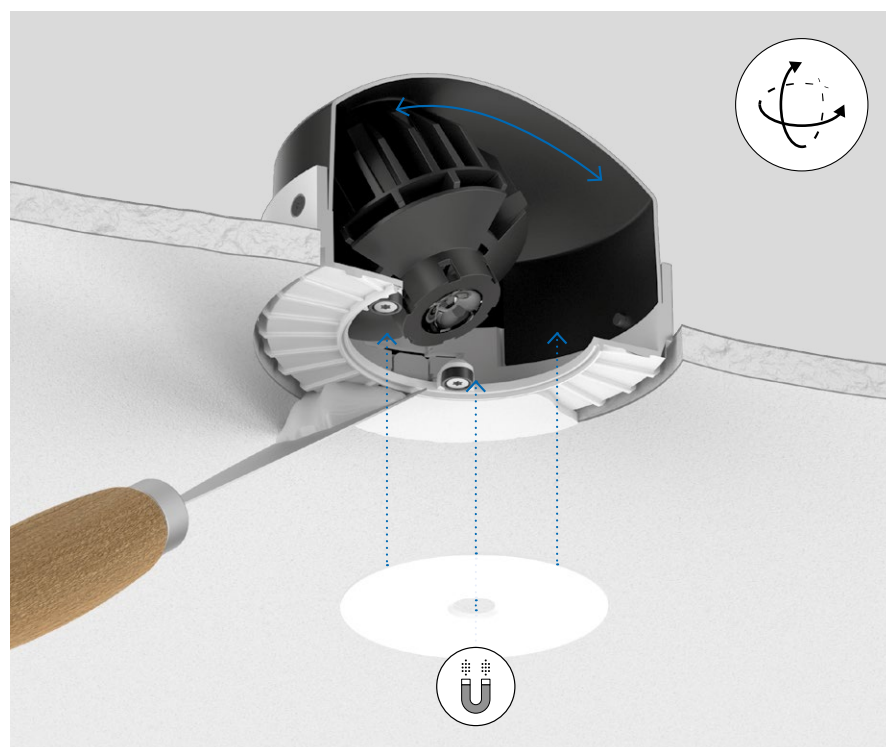
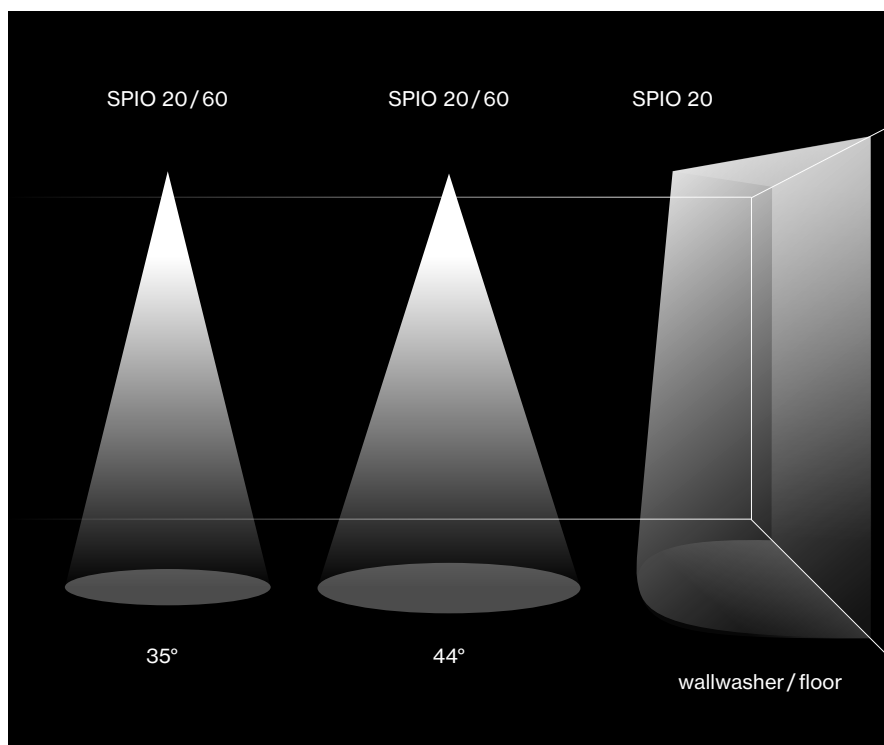

## Precise light adjustment

**EN** The adjustable version of SPIO 60, patent pending, can be moved in all directions thanks to a magnetic plate. The spotlight can thus both be rotated 360° and pivoted up to 30° in all directions. As a result, it offers the greatest flexibility in directing and guiding light exactly where it is desired.

**FR** La version réglable de SPIO 60, en passe d'être brevetée, peut être déplacée dans toutes les directions grâce à une tête de spot magnétique. En outre, le spot peut non seulement pivoter à 360°, mais également être incliné jusqu'à 30° dans toutes les directions. Il offre donc une remarquable liberté d'orientation et de guidage de la lumière à l'endroit précis où on l'attend.

## Smooth and invisible

**EN** The trimless SPIO 60 version can easily be maintained and adjusted thanks to its magnetic cover. The spotlight is completely fitted into a plasterboard ceiling. The recessed housing and ceiling can subsequently be painted over. The spots thus appear "invisible", creating a homogeneous, effective overall impression.

**FR** Grâce à la plaque de recouvrement, la variante sans bord de SPIO 60 est facile à entretenir et à ajuster. Le spot est intégralement encastré dans un plafond en placoplâtre. Le boîtier d'encastrement peut ensuite être peint en même temps que le plafond de la pièce. Les spots paraissent ainsi « invisibles » et l'impression d'homogénéité obtenue est saisissante.



## SPIO 20

recessed

**EN** Round recessed spotlight in die-cast aluminium; installation without tools in mounting set with ball catch system or using snap spring closure; special mounting tool for easy installation of the trimless housing available as an accessory; for trimless installation in plasterboard ceilings; paintable light inset; shadow joint between light inset and mounting set optionally fillable; or with trim; with optional high quality lens system with precise radiation characteristic; or high quality, aluminium, vapour deposition coated reflector with faceted design; precise radiation characteristics with different beam angles; uncluttered ceiling look through recessed lighting level; reduced light-emitting surface - only  $\varnothing 10$  mm (DOWNLIGHT) or  $\varnothing 13$  mm (WALLWASHER/FLOOR); no multiple shadows; energy-eff. LEDs - very good colour rendering

**FR** Spot rond encastrable en fonte d'aluminium injectée ; installation sans outils grâce au kit de montage avec système de fixation à bille ou à par fermeture à ressort à enclenchement ; outil de montage spécial pour faciliter la mise en place du boîtier sans rebord proposé comme accessoire ; pour encastr. sans bord en plafond placoplâtre ; insert d'éclairage peinturable ; joint creux entre l'insert et le kit de montage, enduisible en option ; ou avec bord continu ; également possible avec une optique de lentilles de haute qualité présentant des caractéristiques de rayonnement précises ; ou réflecteur de grande qualité, métallisée à l'aluminium avec optique facette ; précision de caractéristique de rayonnement avec divers angles de diffusion ; plafond harmonieux par luminaire en retrait ; surface réduite pour la sortie de la lumière -  $\varnothing 10$  mm (DOWNLIGHT) ou  $\varnothing 13$  mm (WALLWASHER/FLOOR) seulement ; pas d'ombres multiples ; LED à haut rend. éner. - excellent rendu coul.

### Quickinfo

2700 K, 3000 K  
CRI  $\geq 90$ , 3 SDCM  
up to 70 lm/W  
L95 @ 50000h  
non DIM, DALI-2

### Types



### Colours



### Light distributions



version with  
trim available



10 mm light  
output area



trimless  
installation

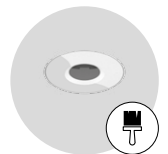

paintable  
cover

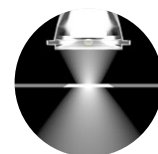

LFO lens  
technology



wallwasher  
floor



## Order options

<b>COLOUR TEMPERATURE</b>	☼☼
2700 K	4
3000 K	5

<b>MATERIAL COLOUR</b>	☑
○ traffic white RAL 9016	7
● jet black RAL 9005	8

<b>REFLECTOR COLOUR</b>	
● jet black RAL 9005	
paintable cover	

<b>BEAM ANGLE</b>	▲
flood 35°	F
wide flood 44°	W

## Options on request

<b>COLOUR RENDERING INDEX</b>	
CRI ≥ 95, 2 SDCM	

<b>COLOUR TEMPERATURE</b>	
4000 K	

<b>CONCRETE HOUSING</b>	
primed concrete ceiling	
exposed concrete ceiling	

<b>REFLECTOR COLOUR</b>	
○ traffic white* RAL9016	
*only for wallwasher / floor	



## SPIO 20 downlight



### DOWNLIGHT TRIMLESS

<b>INSET POWER</b>	<b>LUMINOUS FLUX</b>	<b>ORDER CODE</b>
6.5 W 12 Vf 600mA	435lm	0 4 8 - 1 7 1 0 ☼☼ 1 0 ▲

### TRIMLESS MOUNTING SET for plasterboard ceilings 9–25 mm

<b>COLOUR</b>	<b>ORDER CODE</b>
○ traffic white RAL9016	0 4 8 - 1 6 9 8 1 0 7

### DOWNLIGHT TRIM

<b>INSET POWER</b>	<b>LUMINOUS FLUX</b>	<b>ORDER CODE</b>
6.5 W 12 Vf 600mA	435lm	0 4 8 - 1 6 1 0 ☼☼ 1 ▲

## SPIO 20 wallwasher / floor



### WALLWASHER / FLOOR TRIMLESS

<b>INSET POWER</b>	<b>LUMINOUS FLUX</b>	<b>ORDER CODE</b>
5.9 W 5.6 Vf 1050mA	414lm	0 4 8 - 1 7 3 0 ☼☼ 1 0 8 W

### TRIMLESS MOUNTING SET for plasterboard ceilings 9–25 mm

<b>COLOUR</b>	<b>ORDER CODE</b>
○ traffic white RAL9016	0 4 8 - 1 6 9 8 1 0 7

### WALLWASHER / FLOOR TRIM

<b>INSET POWER</b>	<b>LUMINOUS FLUX</b>	<b>ORDER CODE</b>
5.9 W 5.6 Vf 1050mA	414lm	0 4 8 - 1 6 3 0 ☼☼ 1 8 W

## Mounting accessories

### SPECIAL MOUNTING TOOL

<b>TYPE</b>	<b>Ø-H (mm)</b>	<b>ORDER CODE</b>
SPIO 20	73-107	0 4 8 - 1 6 9 0 0 0 0

necessary to install mounting housing trimless

## Electrical accessories

### POWER SUPPLY 220-240 V AC, 50-60Hz, □ PC II

TYPE	EFFICIENCY	L-W-H (mm)	ORDER CODE
600 mA   max. 43 V   non DIM	η 85 %	147-44-22	0 0 2 - 9 0 7 8 3
600 mA   max. 46 V   DALI-2	η 85 %	143-43-30	0 0 2 - 9 0 7 8 4
1050 mA   max. 25 V   non DIM	η 85 %	111-38-28	0 0 2 - 9 0 7 8 7
1050 mA   max. 42 V   DALI-2	η 85 %	143-43-30	0 0 2 - 9 0 7 8 8

revision opening required

### DIN RAIL COMPONENTS

TYPE	W-H-D (mm)	ORDER CODE
POWER SUPPLY 220-240 V AC	72-90-63	0 0 5 - 6 5 2 0 2 1 0
160 W   48 V DC constant voltage		
LED DRIVER DALI-2 DT6 1-2 addr.	36-88-59	0 0 5 - 6 1 2 1 0 3 0
200-1050 mA settable const. current		
2 × 42 W   48 V DC   U <sub>OUT</sub> 10-40 V		

for more details and components see XAL 22 catalog, page 980

**INSET POWER** is the current consumption excluding any ballast

**LUMINOUS FLUX** value calculated for 3000 K, CRI ≥ 90, colour white, lens wide flood, 2700 K -3 %

**Private Residence**  
Visualisation





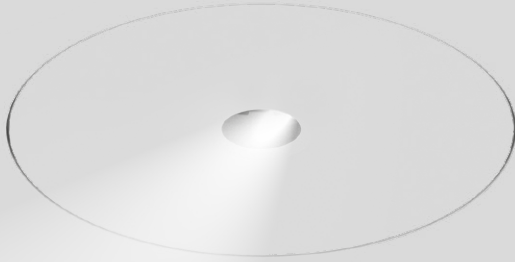

reddot winner 2022



## SPIO 60

recessed

**EN** Round recessed spotlight in die-cast aluminium; installation without tools in mounting set with ball catch system or with magnetic attachment; for trimless installation in plaster-board ceilings; paintable cover; shadow joint between cover and mounting set optionally fillable; or with trim; choice of adjustable or fixed symmetric radiation characteristic; high quality lens system; uncluttered ceiling look through recessed lighting level; reduced light-emitting surface (only  $\varnothing 10$  mm); no multiple shadows; efficient LEDs with very good colour rendering

**FR** Spot rond encastrable en fonte d'aluminium injectée ; montage sans outil en kit de montage par système à dé clic à bille ou avec fixation magnétique ; pour encastr. sans bord en plafond placoplâtre ; plaque de couverture peinturable ; joint creux entre la plaque de couv. et le kit de montage plâtrable en opt. ; ou avec bord continu ; caractéristiques de rayonnement au choix réglables ou fixes symétriques ; optique lentille de grande qualité ; plafond harmonieux par luminaire en retrait ; surface de diffusion réduite ( $\varnothing 10$  mm seulement) ; pas d'ombres multiples ; LED économes en énergie à restitution de couleur élevée

### Quickinfo

2700 K, 3000 K  
CRI  $\geq 90$ , 3 SDCM  
up to 60 lm/W  
L95 @ 50000 h  
non DIM, DALI-2

### Types

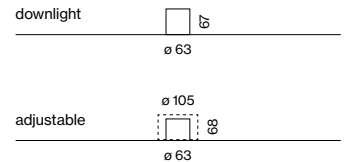

### Colours



### Light distributions



version with trim available



10mm light output area



trimless installation

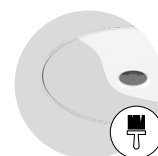

paintable cover

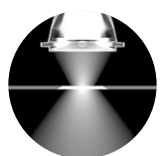

LFO lens technology

### Order options

<b>COLOUR TEMPERATURE</b>	••
2700 K	4
3000 K	5

<b>MATERIAL COLOUR</b>
○ traffic white RAL9016
paintable cover

<b>BEAM ANGLE</b>	▲
flood 35°	F
wide flood 44°	W

### Options on request

<b>COLOUR TEMPERATURE</b>
4000 K

<b>CONCRETE HOUSING</b>
primed concrete ceiling
exposed concrete ceiling

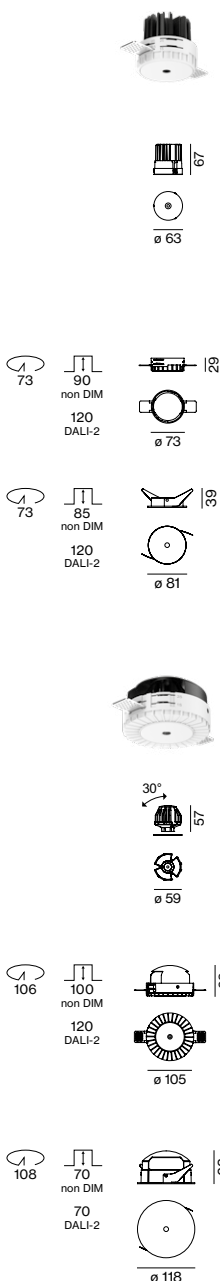

### SPiO 60 downlight



#### DOWNLIGHT

<b>INSET POWER</b>	<b>LUMINOUS FLUX</b>	<b>ORDER CODE</b>
11.9 W 12 Vf 1050 mA	718 lm	0 4 8 - 1 5 1 0 •• 1 7 ▲

### Mounting accessories

**TRIMLESS MOUNTING SET** for plasterboard ceilings 12.5/15/25 mm

<b>COLOUR</b>	<b>ORDER CODE</b>
○ traffic white RAL9016	0 4 8 - 2 6 9 6 1 1 7

**MOUNTING SET WITH TRIM** for intermediate ceilings 2–25 mm

<b>COLOUR</b>	<b>ORDER CODE</b>
○ traffic white RAL9016	0 4 8 - 1 5 9 7 2 0 7
● jet black RAL 9005	0 4 8 - 1 5 9 7 2 0 8

### SPiO 60 adjustable



#### ADJUSTABLE

<b>INSET POWER</b>	<b>LUMINOUS FLUX</b>	<b>ORDER CODE</b>
11.9 W 12 Vf 1050 mA	685 lm	0 4 8 - 1 5 2 0 •• 1 7 ▲

### Mounting accessories

**TRIMLESS MOUNTING SET** for plasterboard ceilings 12.5/15/25 mm

<b>COLOUR</b>	<b>ORDER CODE</b>
○ traffic white RAL9016	0 4 8 - 1 5 9 8 1 0 7

**MOUNTING SET WITH TRIM** for intermediate ceilings 2–25 mm

<b>COLOUR</b>	<b>ORDER CODE</b>
○ traffic white RAL9016	0 4 8 - 1 5 9 7 1 0 7
● jet black RAL 9005	0 4 8 - 1 5 9 7 1 0 8

### Electrical accessories

**POWER SUPPLY** 220-240 V AC, 50-60 Hz, □ PC II

TYPE	EFFICIENCY	L-W-H (mm)	ORDER CODE
1050 mA   non DIM	η 85 %	111-38-28	0 0 2 - 9 0 7 8 7
1050 mA   DALI-2	η 85 %	143-43-30	0 0 2 - 9 0 7 8 8

#### DIN RAIL COMPONENTS

TYPE	W-H-D (mm)	ORDER CODE
POWER SUPPLY 220-240 V AC	72-90-63	0 0 5 - 6 5 2 0 2 1 0
160 W   48 V DC constant voltage		
LED DRIVER DALI-2 DT6 1–2 addr.	36-88-59	0 0 5 - 6 1 2 1 0 3 0
200–1050 mA settable const. current		
2 × 42 W   48 V DC   U <sub>OUT</sub> 10–40 V		

for more details and components see XAL 22 catalog, page 980

**INSET POWER** is the current consumption excluding any ballast  
**LUMINOUS FLUX** value calculated for 3000 K, CRI ≥ 90, colour white, lens wide flood, 2700 K -5 %

**Private Residence**  
Visualisation





# High-precision shelf lighting

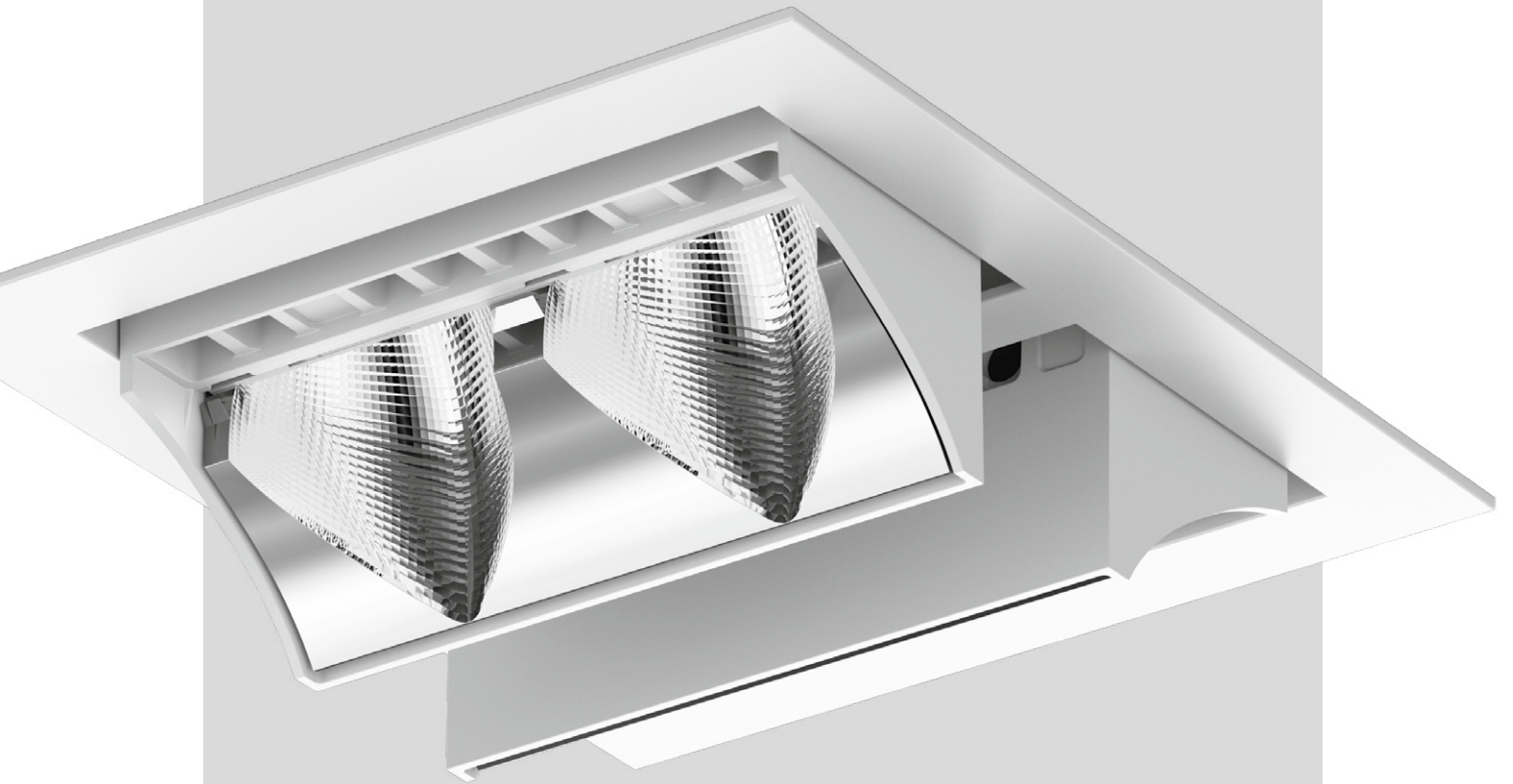



# SQUADRO

**EN** SQUADRO is a track-mounted and recessed spotlight, in a two-lamp single- or double-sided version, for the retail sector that bundles six essential retail requirements in one luminaire. Free-form reflectors with faceted optics make a polished presentation of goods possible. These reflectors direct the light precisely into shelves or aisle zones. Directed light creates a modelling effect on the products and delivers attractive staging. Swivelling light modules illuminate specific shelf levels or billboards while providing plenty of basic lighting. SQUADRO spotlights are completely glare-free, both transversely and longitudinally. They are highly efficient in their energy balance with an efficiency of over 90 %.

**FR** SQUADRO est un spot encastré sur rail disponible en version à 2 lampes d'un côté ou de deux côtés, qui réunit dans un seul luminaire une solution d'éclairage 6 en 1 pour les magasins de détail. Il garantit une présentation brillante des produits grâce à des réflecteurs à facettes de forme libre : ceux-ci dirigent la lumière de manière précise et avec un réglage au plus juste vers les rayonnages ou les allées. Grâce au grand effet de profondeur, les produits alimentaires bénéficient de contrastes de couleurs importants et d'une grande attractivité. Les modules d'éclairage orientables éclairent de manière ciblée les niveaux d'étagères ou les panneaux d'affichage tout en assurant un éclairage de base suffisant. Les projecteurs SQUADRO offrent une limitation parfaite de l'éblouissement non seulement dans le sens longitudinal, mais aussi dans le sens transversal. Leur bilan énergétique est extrêmement efficace avec un rendement de plus de 90 %.

## Types



single-sided 1×2    double-sided 2×2    single-sided 1×2    double-sided 2×2

## Mountings

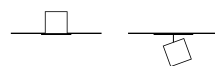

recessed    track

## Light distributions

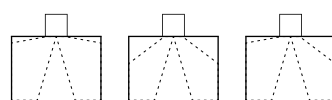

wall floor    shelf floor    wall/shelf floor

## 6-in-1 Lighting solution

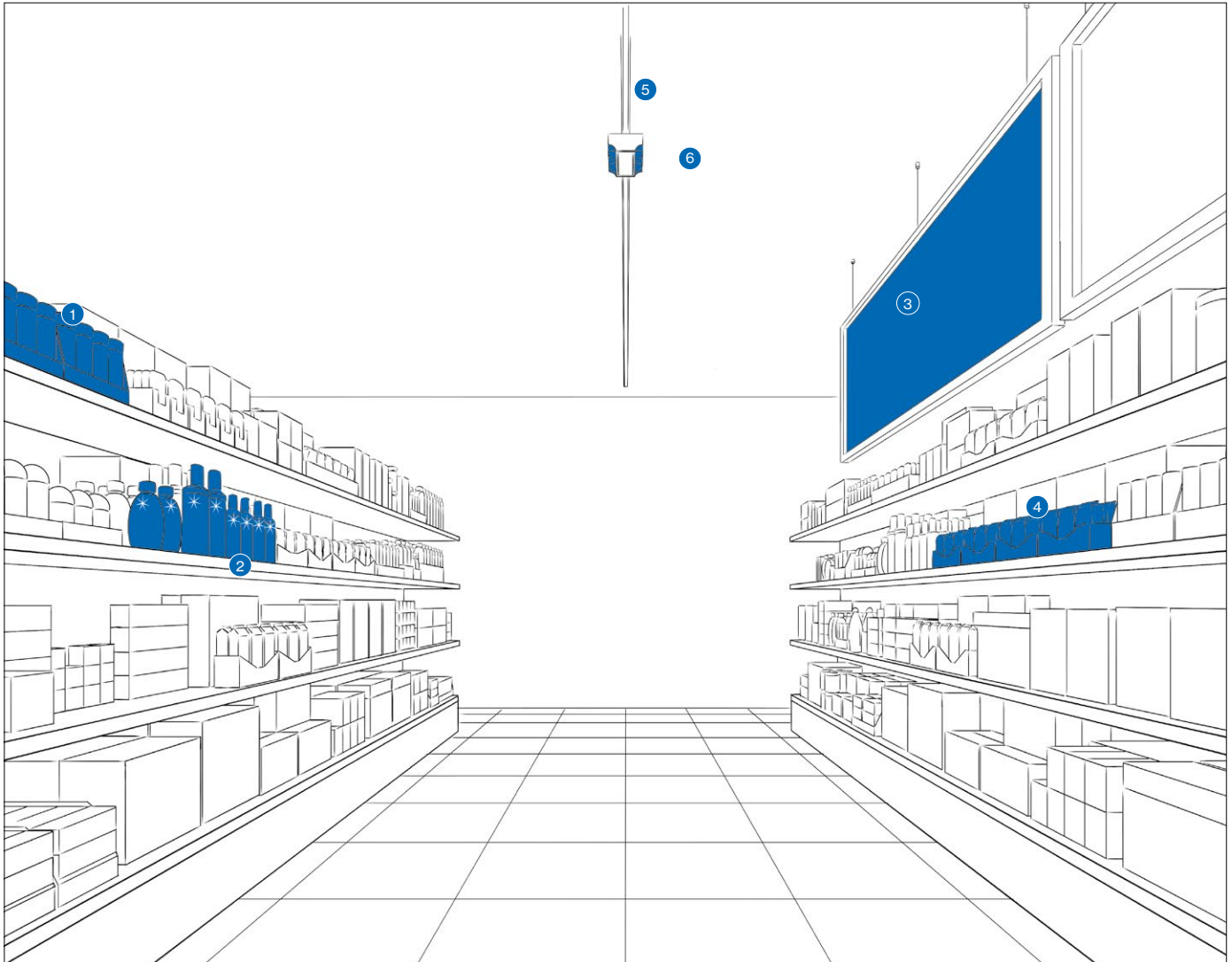

**EN** SQUADRO combines all the advantages of traditional retail lighting solutions in one luminaire. The spotlights are transversely and longitudinally glare-free and direct the light precisely onto the goods – into the heights and depths of the shelves. This achieves a strong product presentation. Thanks to proper light distribution, no additional light source is required for basic lighting.

**FR** SQUADRO combine en un seul luminaire tous les avantages des solutions d'éclairage classiques proposées pour le commerce de détail. Ces spots sont non éblouissants transversalement et longitudinalement et dirigent la lumière avec précision sur les produits, jusque très haut et très bas dans les étagères. Cela permet d'obtenir une forte mise en valeur du produit. Grâce à une bonne répartition de la lumière, aucune source de lumière supplémentaire n'est nécessaire pour l'éclairage d'ambiance.

**1** **EN** The highest illuminance is on the upper two presentation levels.

**FR** L'intensité lumineuse la plus élevée est située sur les deux niveaux supérieurs de présentation.

**2** **EN** Highlights on premium goods create a brilliant staging.

**FR** Les produits sont mis en scène de manière attrayante et brillante.

**3** **EN** Directed light creates accents on billboards and subjects.

**FR** La lumière orientée permet d'attirer l'attention sur des panneaux publicitaires et des objets.

**4** **EN** The high depth effect gives food high colour contrasts and attractiveness.

**FR** Grâce à l'important effet de profondeur, les aliments présentent de forts contrastes de couleurs et des points brillants.

**5** **EN** Due to longitudinal glare control, the lighting system is barely perceptible to the customer in the direction of the aisle.

**FR** Grâce à l'antiéblouissement longitudinal, le système d'éclairage est à peine perceptible pour le client dans le sens de la marche.

**6** **EN** Transverse glare control additionally prevents glare from any viewing direction.

**FR** L'antiéblouissement transversal empêche de surcroît l'éblouissement sous tous les angles.

## Five versions

**EN** SQUADRO's five variants with diverse beam characteristics respond to different shop layouts and requirements. Perfect alignment ensures that minimal luminaires radiate as much light as possible onto the merchandise. SQUADRO adapts to the conditions and illuminates selectively and without scatter loss. All goods are thus attractively presented regardless of the size or interior design of the shop.

**FR** SQUADRO répond aux exigences et aux agencements de boutiques les plus divers avec cinq variantes présentant différentes caractéristiques de rayonnement. Afin que peu de lampes envoient autant de lumière que possible sur les produits, ce qui importe est une orientation parfaite. SQUADRO s'adapte à la conformation du site et éclaire de manière ciblée et sans perte de diffusion. Ainsi, tous les produits, quels que soient la taille ou le design intérieur du magasin, sont mis en scène de manière attrayante.

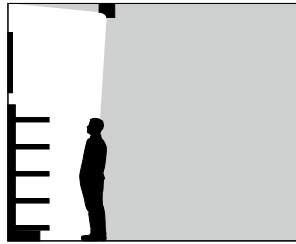

Wall Floor (single-side)

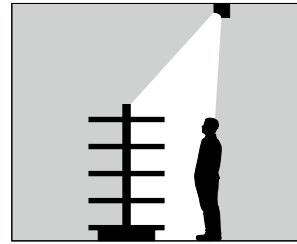

Shelf Floor (single-side)

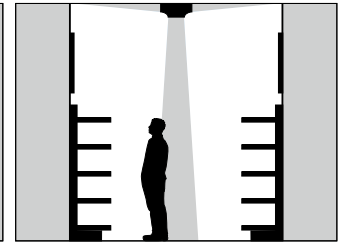

Wall Floor (double-side)

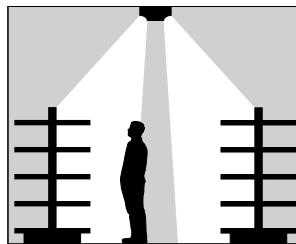

Shelf Floor (double-side)

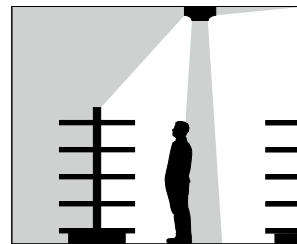

Shelf / Wall Floor

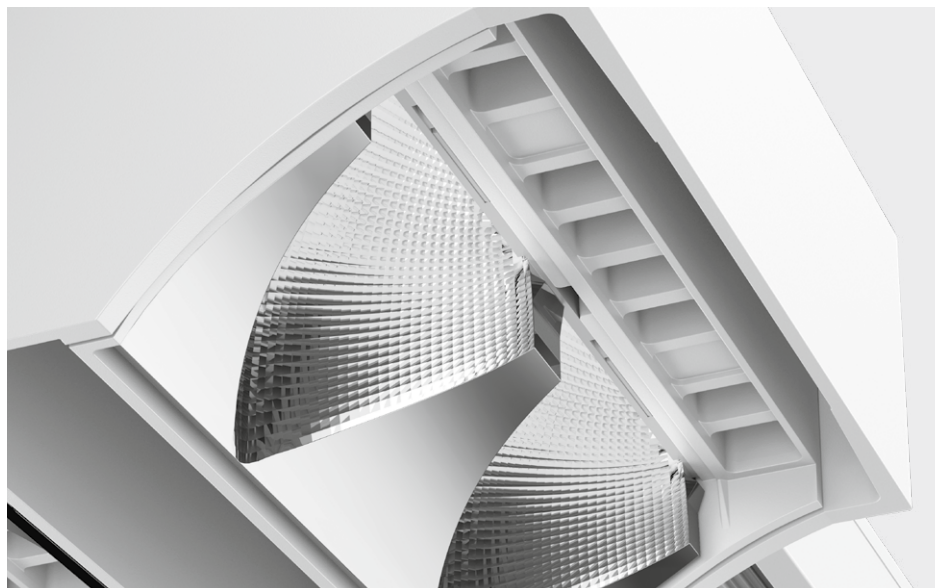

## Unique reflector technology

**EN** Custom free-form reflectors ensure high-precision light control; each SQUADRO achieves an efficiency of over 90 per cent. The spotlights enjoy optimum glare control through the curved shape and secondary reflector technology.

**FR** Des réflecteurs spéciaux à facettes assurent un guidage hautement précis de la lumière, et chaque SQUADRO atteint un degré d'efficacité de plus de 90 pour cent. L'anti-éblouissement est obtenu par la forme incurvée et la technologie de réflecteurs secondaires des spots.

## Effective lighting

**EN** Branches of the same chain often differ in their shop architecture. Shelf heights and aisle widths may vary from one location to another. The solution is step-adjustable light modules. The elements can be tilted from  $-15^\circ$  to  $+20^\circ$ . Each module can be tilted asymmetrically, allowing precise alignment and thus optimum light control.

**FR** Les filiales d'une même chaîne se différencient souvent par l'architecture du magasin. Les hauteurs des étagères et la largeur des allées peuvent varier selon les sites. La solution : des modules d'éclairage réglables graduellement. Les éléments sont inclinables de  $-15^\circ$  à  $+20^\circ$ . Chaque module peut être incliné de manière asymétrique et permet une orientation précise et donc un guidage optimal de la lumière.



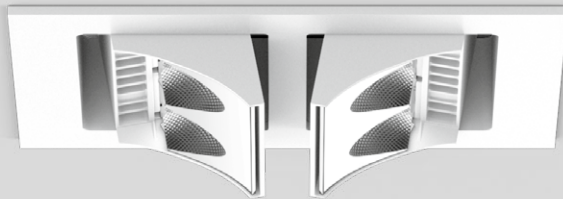
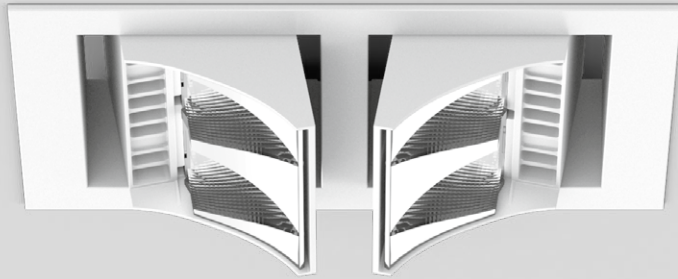

## SQUADRO wallwasher

recessed

**EN** Recessed ceiling spotlight in die cast aluminium in two different types (2 lamps or 2×2 lamps) and with 2 types of light modules (for shelf floor washer and wall floor washer); with trim; surface powder coated; installation without tools using snap spring closure; aisle spotlight with special, multi-free-form, facet effect surface reflectors for high precision light control; precise shelf and aisle zone lighting, optimum longitudinal glare control for high viewing comfort in the aisle zone, adjustable light modules; COB (Chip on Board) technology for maximum efficiency; efficient LEDs with very good colour rendering; IP40 protection glass available as an accessory

**FR** Spot encastré en aluminium moulé en 2 variantes différentes (à 2 lampes ou 2×2 lampes) et avec deux modules lumineux différents (pour shelf floor washer et wall floor washer); avec bord continu; surface thermolaquée; montage sans outil avec fermeture par ressort à déclic; Spot pour couloirs avec réflecteurs spéciaux multiples dotés d'une technologie à forme libre avec optique à facettes pour un guidage extrêmement précis du flux lumineux; éclairage précis des étagères et des couloirs, anti-éblouissement longitudinal optimal pour un confort visuel élevé dans les couloirs, modules lumineux réglables; Technologie COB pour efficacité maximale; LED économes en énergie à restitution de couleur élevée; verre de protection IP40 disponible comme accessoire

### Quickinfo

3000K, 4000K  
CRI ≥ 90, 3 SDCM  
up to 134lm/W  
L80 @ 50 000h  
non DIM, DALI-2

### Types

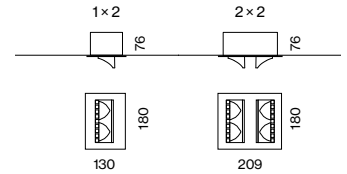

### Colours



### Light distributions



shelf floor wall floor shelf wall floor



DiiA® standards  
251, 252, 253



up to 134lm/W  
(high efficiency)

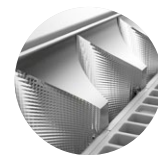

glare-free reflector  
longitudinally &  
transversely

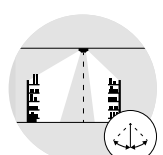

+20° up to -10°  
tiltable

**Order options**

**COLOUR TEMPERATURE** ⬢

3000K	0
4000K	1

**CONTROL** ⬆

non DIM	1
DALI-2	3

**MATERIAL COLOUR** ▣

○ traffic white RAL 9016	7
● jet black RAL 9005	8

**REFLECTOR** ▲

shelf floor washer	S
wall floor washer	A
1× shelf / 1× wall floor washer*	B

\*only for 2×2 lamps

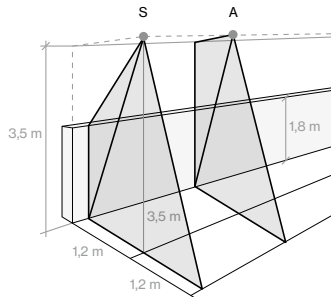

**Options on request**

**COLOUR RENDERING INDEX**

CRI ≥ 80
----------

**Light distributions**

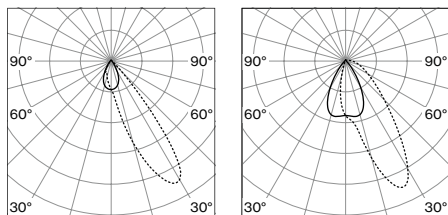

1×2 lamps  
shelf floor washer

1×2 lamps  
wall floor washer

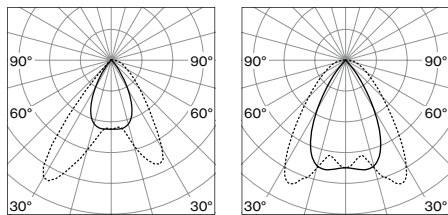

2×2 lamps  
1× shelf / 1× wall floor washer

2×2 lamps  
wall floor washer

**LUMINOUS FLUX** value calculated for 4000K  
CRI ≥ 90, colour white, wall floor washer  
3000K -5%

**SQUADRO wallwasher trim**



**1×2 LAMPS SINGLE-SIDED**

<b>SYSTEM POWER</b>	<b>LUMINOUS FLUX</b>	<b>ORDER CODE</b>
36 W	4720 lm	0 4 9 - 2 0 1 2 <span style="color: blue;">⬢</span> <span style="color: blue;">▣</span> <span style="color: blue;">▲</span>



**2×2 LAMPS DOUBLE-SIDED**

<b>SYSTEM POWER</b>	<b>LUMINOUS FLUX</b>	<b>ORDER CODE</b>
72 W	2 × 4720 lm	0 4 9 - 2 0 2 0 <span style="color: blue;">⬢</span> <span style="color: blue;">▣</span> <span style="color: blue;">▲</span>

**Optical accessories**

**IP 40 PROTECTION GLASS**

<b>TYPE</b>	<b>ORDER CODE</b>
1×2 lamps/single-sided	0 4 9 - 2 9 1 0 0 1 0
2×2 lamps/double-sided	0 4 9 - 2 9 2 0 0 1 0

**Technical data**

**SQUADRO 1×2 lamps, shelf wall washer, trim, 36 W, 3000 K**

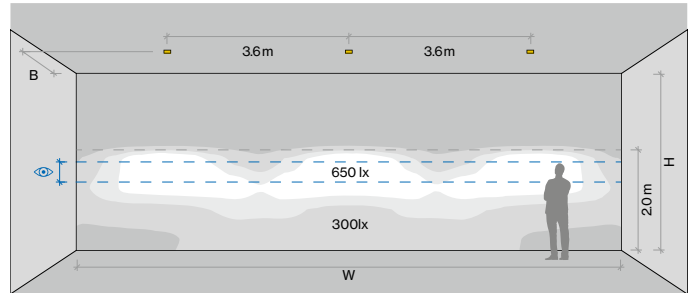

**SQUADRO 1×2 lamps, wall floor washer, trim, 36 W, 3000 K**

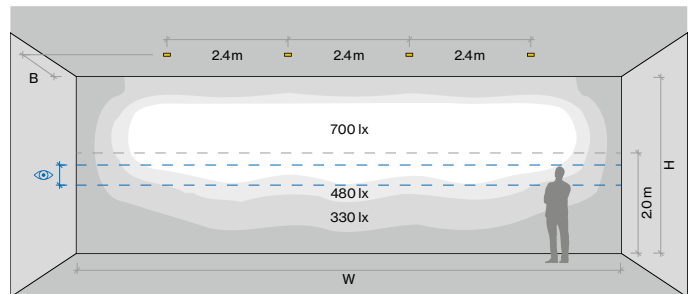

<b>ROOM VALUES</b>	<b>CALCULATION SURFACE</b>
Wall dimensions H = 3.5 m   W = 10.8 m	Surface dimensions 10.8 × 3.5 m
Distance to wall B = 1.3 m	Surface height 0 – 3.5 m
Aisle width 2.6 m	
Reflection factor 0.7   0.7   0.2	Eye level <span style="color: blue;">👁</span> 1.35 m – 1.75 m
Maintenance factor 0.9	

**Euroshop** Dusseldorf, DE –  
by blocher partners







## SQUADRO wallwasher

track

**EN** Track light in die cast aluminium in two different types (2 lamps or 2x2 lamps) and with 2 types of light modules (for shelf floor washer and wall floor washer); surface powder coated; aisle spotlight with special, multi-free-form, facet effect surface reflectors for high precision light control; precise shelf and aisle zone lighting, optimum longitudinal glare control for high viewing comfort in the aisle zone, adjustable light modules; COB (Chip on Board) technology for maximum efficiency; efficient LEDs with very good colour rendering; IP40 protection glass available as an accessory; including attachment for linear alignment of the spotlights

**FR** Spot sur rail en aluminium moulé en 2 variantes différentes (à 2 lampes ou 2x2 lampes) avec deux modules lumineux différents (pour shelf floor washer et wall floor washer) ; surface thermolaquée ; Spot pour couloirs avec réflecteurs spéciaux multiples dotés d'une technologie à forme libre avec optique à facettes pour un guidage extrêmement précis du flux lumineux ; éclairage précis des étagères et des couloirs, anti-éblouissement longitudinal optimal pour un confort visuel élevé dans les couloirs, modules lumineux réglables ; Technologie COB pour efficacité maximale ; LED économes en énergie à restitution de couleur élevée ; verre de protection IP40 disponible comme accessoire ; y compris la fixation pour l'alignement linéaire des projecteurs

### Quickinfo

3000K, 4000K  
CRI ≥ 90, 3 SDCM  
up to 134lm/W  
L80 @ 50 000h  
non DIM, DALI-2

### Types

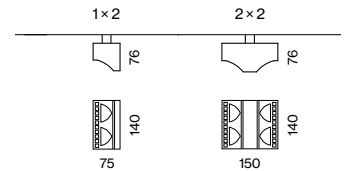

### Colours



### Light distributions

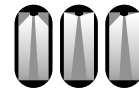

shelf floor wall floor shelf wall floor

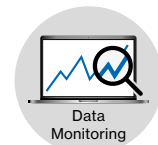

DiiA® standards  
251, 252, 253



up to 134lm/W  
(high efficiency)



glare-free reflector  
longitudinally &  
transversely

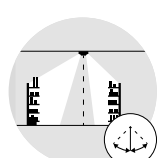

+20° up to -10°  
tiltable



**Order options**

**COLOUR TEMPERATURE** ⬢

3000K	0
4000K	1

**CONTROL** ⬢

non DIM	1
DALI-2	3

**MATERIAL COLOUR** ⬢

○ traffic white RAL 9016	7
● jet black RAL 9005	8

**REFLECTOR** ▲

shelf floor washer	S
wall floor washer	A
1×shelf/1×wall floor washer*	B

\*only for 2×2 lamps

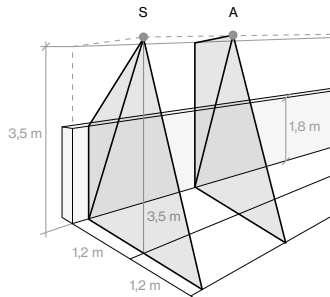

**Options on request**

**COLOUR RENDERING INDEX**

CRI ≥ 80
----------

**CONTROL**

DALI-2 (2×2 lamps)
--------------------

**Light distributions**

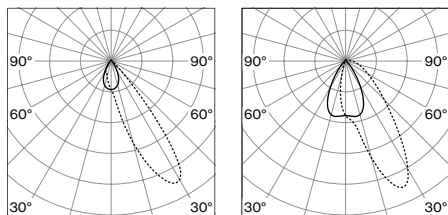

1×2 lamps  
shelf floor washer

1×2 lamps  
wall floor washer

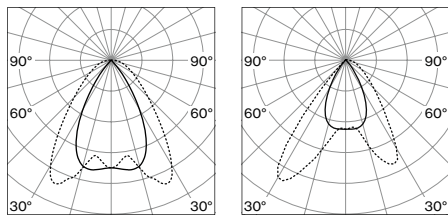

2×2 lamps  
wall floor washer

2×2 lamps  
1×shelf/1×wall floor washer

**LUMINOUS FLUX** value calculated for 4000K  
CRI ≥ 90, colour white, wall floor washer  
3000K -5%

**SQUADRO wallwasher track**



**1×2 LAMPS SINGLE-SIDED**

<b>SYSTEM POWER</b>	<b>LUMINOUS FLUX</b>	<b>ORDER CODE</b>
36W	4720lm	149-2210 <span style="color: blue;">⬢</span> <span style="color: blue;">▲</span>



**2×2 LAMPS DOUBLE-SIDED**

<b>SYSTEM POWER</b>	<b>LUMINOUS FLUX</b>	<b>ORDER CODE</b>
72W	2×4720lm	149-2220 <span style="color: blue;">⬢</span> <span style="color: blue;">▲</span>

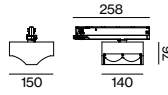
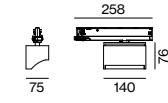

**Optical accessories**

**IP 40 PROTECTION GLASS**

<b>TYPE</b>	<b>ORDER CODE</b>
1×2 lamps/single-sided	049-2910010
2×2 lamps/double-sided	049-2920010

**Technical data**

**SQUADRO 1×2 lamps, shelf wall washer, trim, 36W, 3000K**

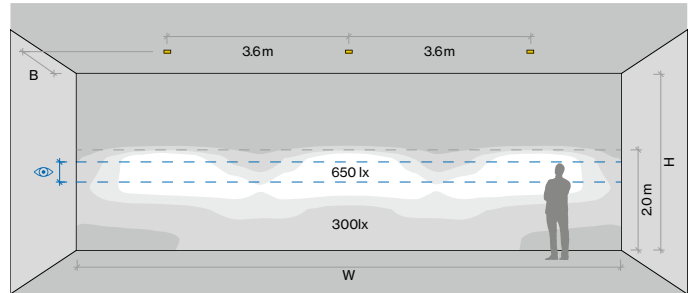

**SQUADRO 1×2 lamps, wall floor washer, trim, 36W, 3000K**

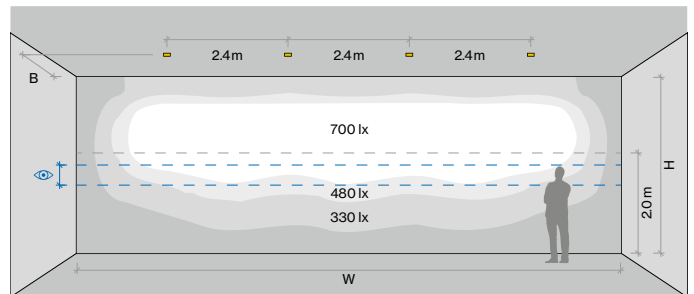

**ROOM VALUES**

Wall dimensions	H = 3.5m   W = 10.8m
Distance to wall	B = 1.3m
Aisle width	2.6m
Reflection factor	0.7   0.7   0.2
Maintenance factor	0.9

**CALCULATION SURFACE**

Surface dimensions	10.8×3.5m
Surface height	0 – 3.5m
Eye level	1.35m – 1.75m

**Jelmoli Store**  
Zurich, CH



Oasis Store Melbourne, AU –  
by Sync Design



# In the spotlight

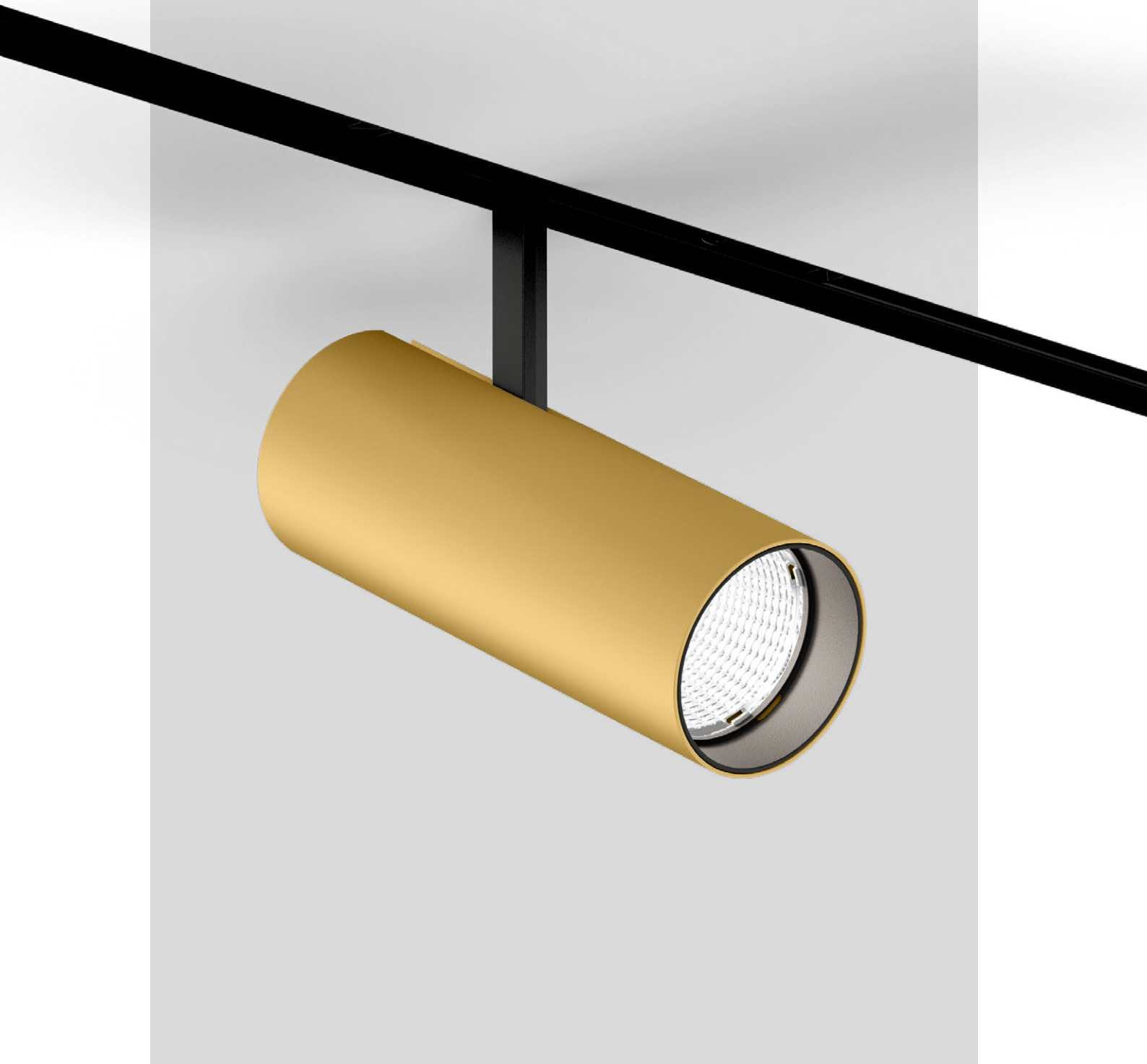

## BO intrack

**EN** Elegant and flexible – this is what characterises the BO track spotlight series. Several sizes and different beam angles offer enormous freedom in setting the scene. The Intrack versions are available as one-, two-, or three-flame spotlights. In addition, the spots can be rotated and pivoted at different angles, making BO an ideal spotlight for shops and staging areas. Different housing and light colours (2700 K, 3000 K, or 4000 K) offer flexibility in different architectural concepts and promise very good colour rendering of up to  $\text{CRI} \geq 95$  (2-SDCM).

**FR** Esthétique et flexible : voilà ce qui caractérise la série de spots sur rail BO. Grâce à plusieurs tailles et différents angles de diffusion, vous avez une grande liberté de mise en scène. Les variantes Intrack sont disponibles en tant que projecteurs à une, deux ou trois lampes. De plus, les spots peuvent être tournés et orientés selon différents angles, ce qui fait de BO un projecteur idéal pour les magasins et les surfaces de présentation. Les différentes couleurs de boîtier et de lumière (2700 K, 3000 K ou 4000 K) offrent une grande flexibilité dans différents concepts architecturaux et promettent un très bon rendu des couleurs allant jusqu'à un IRC  $\geq 95$  (2-SDCM).

### Types

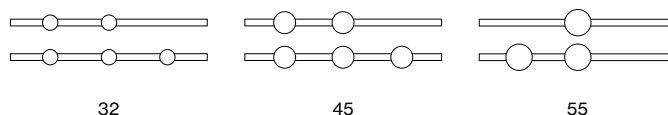

### Mounting



track

### Light distribution

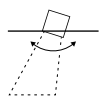

spotlight

## Matched proportions

**EN** Elegance in the right measure: All BO product family spotlights are characterised by their decorative and simple aesthetics. Thanks to their reduced design and precisely coordinated proportions, all BO models can be combined with each other.

**FR** BO incarne l'élégance dans la juste mesure. Tous les projecteurs de cette famille se signalent par une esthétique décorative et sobre. Grâce à leur design réduit et à leurs proportions parfaitement harmonisées, toutes les variantes de BO peuvent être combinées entre elles.



## Colour variety

**EN** BO is available in standard white and black. For even more design freedom, additional colour options are available so that you can tailor BO to your individual project. Learn more about our colour palette at [xal.com/colours](http://xal.com/colours).

**FR** La famille de produits BO est disponible dans les couleurs standard blanc et noir. Pour une plus grande liberté de conception, d'autres variantes de couleurs sont disponibles - vous pouvez ainsi adapter BO à votre projet individuel. Pour en savoir plus sur notre palette de couleurs, rendez-vous sur [xal.com/colours](http://xal.com/colours).



[xal.com/colours](http://xal.com/colours)

## Variety

**EN** The BO Intrack versions are available as single-, double-, or triple-flame spotlights. The spotlight heads are available in three different diameters and different housing and light colours (2700 K, 3000 K, or 4000 K), offering even more flexibility for unique projects. The multi-flame version of the Inset requires only one control gear, which means that the individual spotlights are closer together. This makes these variants not only space-saving but also more cost-efficient.

**FR** BO Intrack est disponible en trois variantes avec un, deux ou trois spots. Les têtes de projecteur proposées en trois diamètres différents et les différentes couleurs de boîtier et températures de lumière (2700 K, 3000 K ou 4000 K) offrent encore plus de flexibilité pour des projets uniques. La finition de l'insert à plusieurs spots ne nécessite qu'un seul système, ce qui rapproche les différents projecteurs les uns des autres. Ainsi, ces variantes sont non seulement moins encombrantes, mais permettent également de réduire les coûts d'acquisition.

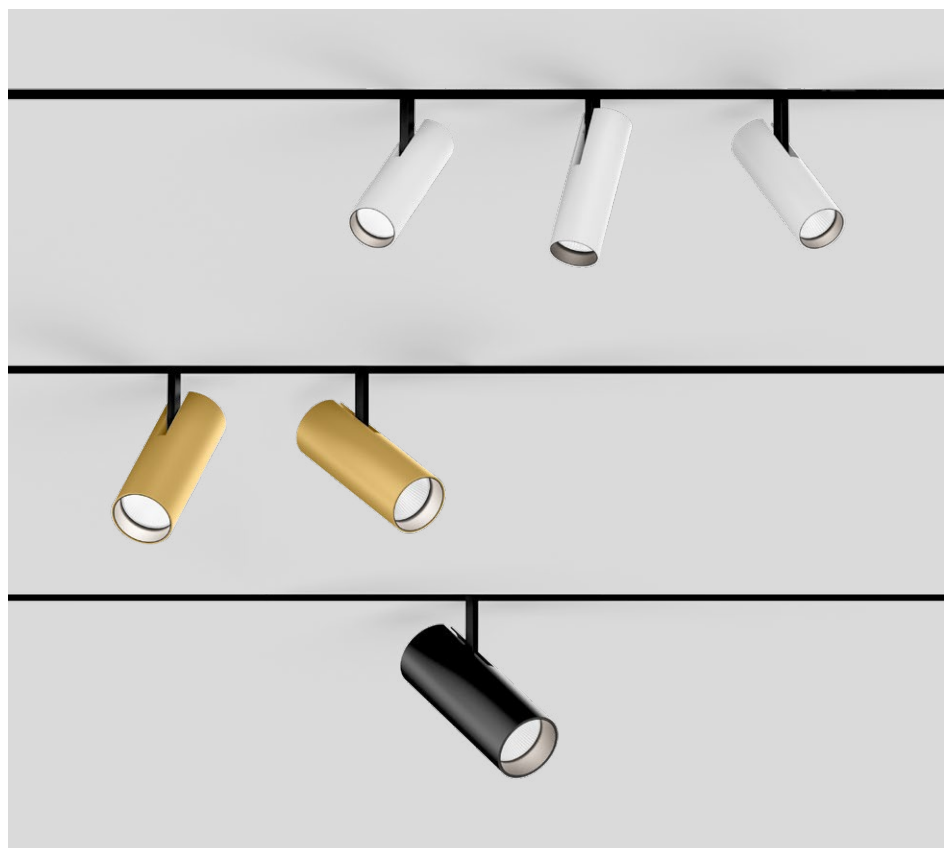



## Intrack

**EN** Flexible adjustment – easy installation: In the track version, BO combines different sizes and beam angles. Thus, ever new lighting scenarios can be implemented: from the selective presentation of goods and products to the staging of art objects and home accessories. The converter disappears elegantly into the track.

**FR** Ajustement flexible - montage facile : dans la variante Track, BO réunit différentes tailles et différents angles de rayonnement. Il est ainsi possible de réaliser des mises en scène lumineuses sans cesse renouvelées : de la présentation ponctuelle de marchandises et de produits à la mise en scène d'objets d'art et d'accessoires d'intérieur. Le convertisseur disparaît élégamment dans le rail.

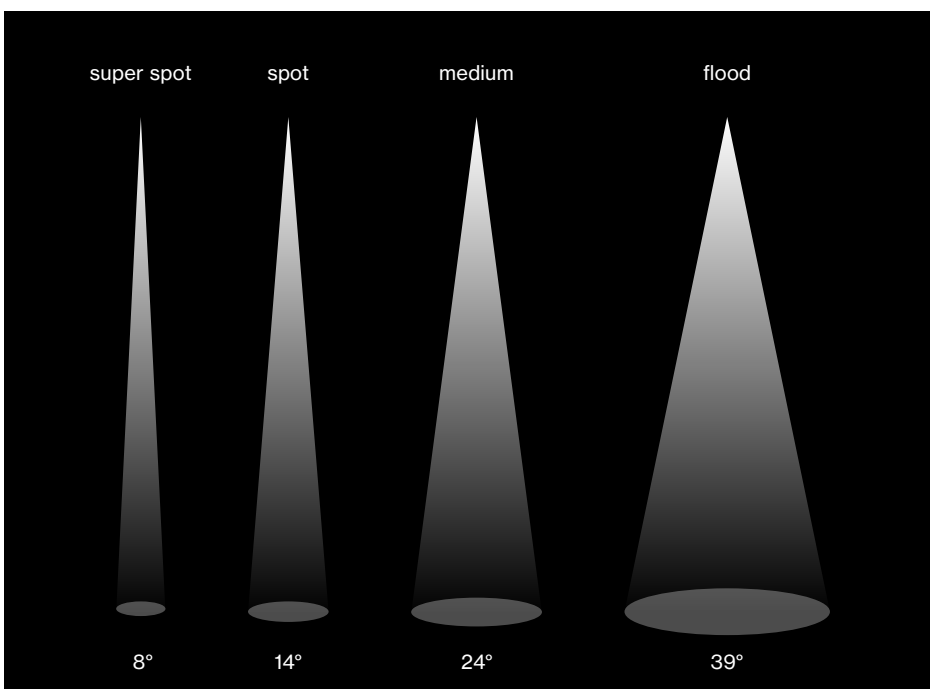

## Flexible adjustment

**EN** BO adapts to the requirements to ensure that objects are presented in the best possible light. The spotlight comes in different beam angles and is rotatable by at least 360°, as well as 90° tiltable.

**FR** Pour que les objets soient toujours mis en valeur de la meilleure manière possible, BO évolue en fonction de chaque exigence. Le projecteur est non seulement disponible en différents angles de rayonnement, mais est également orientable de 360° au minimum dans le plan horizontal et de 90° dans le plan vertical.



## BO 32/45/55

intrack

**EN** Track light made of die-cast aluminium; powder coated; spotlight head rotates 360° and tilts 90°; choice of single lamp, double lamps or triple lamp; converter in the adapter; with optional high quality lens system with precise radiation characteristic; or high quality, aluminium, vapour deposition coated reflector with faceted design; precise radiation characteristics with different beam angles; good glare reduction due to recessed light point plane; optical attachments as accessories; COB (Chip on Board) technology or high power LEDs - maximum efficiency; no multiple shadows; energy-eff. LEDs - very good colour rendering; adapter for toolless insertion or movement on a variety of 3-phase power tracks; adapter flush with the power track

**FR** Spot sur rail en fonte d'aluminium injectée ; thermolaquée ; tête de spot pivotant à 360° et orientable à 90° ; au choix à une, deux ou trois lampes ; convertisseur dans l'adaptateur ; également possible avec une optique de lentilles de haute qualité présentant des caractéristiques de rayonnement précises ; ou réflecteur de grande qualité, métallisé à l'aluminium avec optique facette ; précision de caractéristique de rayonnement avec divers angles de diffusion ; bon anti-éblouissement grâce aux points lumineux en retrait ; éléments optiques comme accessoires ; technologie COB ou High-Power-LED - efficacité maximale ; pas d'ombres multiples ; LED à haut rend. éner. - excellent rendu coul. ; adaptateur pour installation ou déplacement sans outil dans différents rails triphasés ; adaptateur à fleur de rail d'alimentation

### Quickinfo

2700 K, 3000 K, 4000 K  
 CRI ≥ 90, 2 SDCM  
 BO 32 up to 69 lm/W  
 BO 45 up to 91 lm/W  
 BO 55 up to 85 lm/W  
 L80 @ 50 000 h  
 DALI-2

### Types

BO 32	BO 45	BO 55

### Colours



### Light distributions

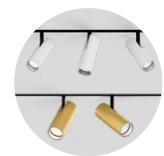
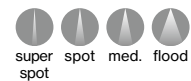

only one adapter  
with 2 or 3 lamps

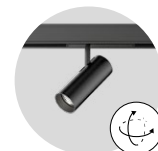

360° rotatable  
90° tiltable



glare control via  
honeycomb louver

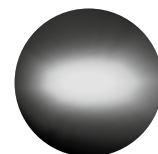

oval lens for oval  
light illumination



CRI ≥ 95  
2 SDCM



## Order options

<b>COLOUR TEMPERATURE</b>	☼☼
2700K	4
3000K	5
4000K	6

### CONTROL

DALI-2

### MATERIAL COLOUR

○ traffic white RAL 9016	7
● jet black RAL 9005	8
🌈 special colours	X

### BEAM ANGLE BO 32

spot 18°	S
medium 23°	M
flood 37°	F

### BEAM ANGLE BO 45

super spot 8°	V
spot 14°	S
medium 24°	M
flood 39°	F

### BEAM ANGLE BO 55

spot 17°	S
medium 23°	M
flood 37°	F

## Options on request

### COLOUR RENDERING INDEX

CRI ≥ 95, 2 SDCM

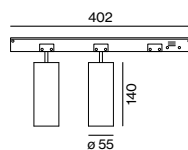
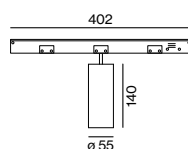
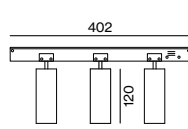
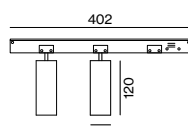
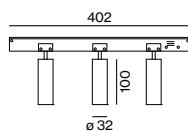
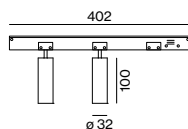

## BO 32 intrack



### TRACK LIGHT

TYPE	SYS. POWER	LUMINOUS FLUX	ORDER CODE
2 lamps	20.5W	1440lm	180-7140:3☑▲
3 lamps	28.8W	2020lm	180-7150:3☑▲

## BO 45 intrack



### TRACK LIGHT

TYPE	SYS. POWER	LUMINOUS FLUX	ORDER CODE
2 lamps	14.2W	super spot 2 × 320lm	180-7240:3☑V
	30W	spot 2 × 1020lm	180-7240:3☑S
	32W	med., flood 2 × 1330lm	180-7240:3☑▲
3 lamps	45W	spot 3 × 1020lm	180-7250:3☑S
	42W	med., flood 3 × 1180lm	180-7250:3☑▲

## BO 55 intrack



### TRACK LIGHT

TYPE	SYS. POWER	LUMINOUS FLUX	ORDER CODE
1 lamp	24.8W	1940lm	180-7330:3☑▲
2 lamps	43W	3460lm	180-7340:3☑▲

## Optical accessories

### HONEYCOMB LOUVER

TYPE	Ø-H (mm)	ORDER CODE
BO 32	30·3	007-1965168
BO 45	42·3	007-1965188
BO 55	50·3	007-1965598

### OVAL LENS

TYPE	Ø-H (mm)	ORDER CODE
BO 32	30·3	007-1965860
BO 45	42·3	007-1965880
BO 55	50·3	007-1965890

### SOFT LENS

TYPE	Ø-H (mm)	ORDER CODE
BO 32	30·3	007-1965960
BO 45	42·3	007-1965980
BO 55	50·3	007-1965990

LUMINOUS FLUX value calculated for 3000K, CRI ≥ 90, colour white, flood 2700K -5%, 4000K +7%

**Euroshop**  
Dusseldorf, DE –  
by blocher partners







BALMAIN  
PARIS

**Oberpollinger | The KaDeWe Group**  
Munich, DE – by Licht Kunst Licht AG  
including lighting design



# Universal expert



# VARO

**EN** As a track-mounted spotlight, VARO focuses on the essentials and can be used universally. It is available in two different sizes and, thanks to its 355° rotation and 90° swivelling capability, is extremely flexible in use. This flexibility is supported by the fact that the spotlights can be inserted and moved along the track without tools. It is ideal for use in shops whose interior design is continually evolving. In addition, the powerful VARO provides maximum efficiency for the illumination of products. The high-quality reflector from VARO ensures a particularly precise beam characteristic at different angles, all with an excellent colour rendering up to  $CRI \geq 90$ . Depending on the desired spatial effect, you can choose between the 3000 K and 4000 K light colours.

**FR** Le projecteur sur rail VARO se concentre sur l'essentiel et peut être employé de manière universelle. Il est disponible en deux tailles et permet une utilisation extrêmement flexible grâce à sa rotation à 355° et à son inclinaison à 90°. Cette flexibilité est renforcée par son installation et son déplacement dans le rail qui s'effectuent sans outil : idéal pour une utilisation dans des boutiques dont la décoration intérieure est en constante évolution. De plus, ce puissant luminaire VARO offre une efficacité maximale pour l'éclairage des marchandises. Le réflecteur de haute qualité du modèle VARO offre une caractéristique de rayonnement particulièrement précise sur angles différents – et ce, avec une excellente restitution des couleurs jusqu'à un IRC  $\geq 90$ . Selon l'effet spatial désiré, vous avez le choix entre les températures de lumière 3000 K et 4000 K.

## Types



80

110

## Mounting



track

## Light distribution

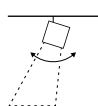

spotlight



## VARO 80 S

track

**EN** Track light made of die-cast aluminium; surface powder coated; spotlight head 355° rotatable and 90° tiltable; integrated converter in the plastic adapter; high quality reflector with spherical facet finish; precise radiation characteristics with different beam angles; installed and exchanged without tools; optical attachments as accessories; optical attachments can be combined; COB (Chip on Board) technology for maximum efficiency; variants with > 120 lm/W available; no multiple shadows; energy-efficient LEDs with very good colour rendering; adapter for toolless insertion or movement on a variety of 3-phase power tracks

**FR** Spot sur rail en fonte d'aluminium injectée ; surface thermolaquée ; tête de spot rotatif à 355° et orientable à 90° ; convertisseur intégré à l'adaptateur plastique ; réflecteur de grande qualité avec optique facette sphérique ; précision de caractéristique de rayonnement avec divers angles de diffusion ; Installation resp. remplacement sans outil ; éléments optiques comme accessoires ; les accessoires optiques peuvent être combinés entre eux ; avec technologie COB (Chip on Board) pour efficacité maximale ; variantes disponibles avec > 120 lm/W ; pas de formation d'ombres multiples ; LED économes en énergie à restitution de couleur élevée ; adaptateur pour installation ou déplacement sans outil dans différents rails trip hasés

### Quickinfo

3000 K, 4000 K  
CRI ≥ 90, 3 SDCM  
up to 129 lm/W  
L95 / 50 000 h  
non DIM, DALI-2

### Type

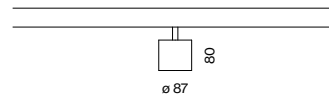

### Colours



### Light distributions



up to 129 lm/W  
(high efficiency)



355° rotatable  
90° tiltable

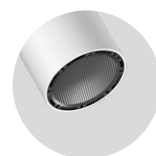

optical  
accessories

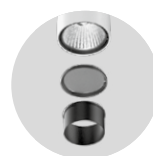

combine 2 optical  
accessories



### Order options

COLOUR TEMPERATURE	
3000K	0
4000K	1

CONTROL	
non DIM	1
DALI-2	3

MATERIAL COLOUR	
○ traffic white RAL 9016	7
● jet black RAL 9005	8

BEAM ANGLE	
spot 17°	S
medium 28°	M
flood 38°	F

### Options on request

COLOUR RENDERING INDEX
CRI ≥ 80

CONTROL
Casambi
DALI-2 (high efficiency)

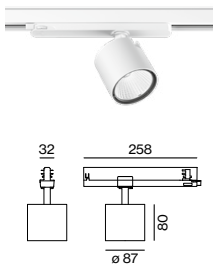

### VARO 80 S track



#### TRACK LIGHT

SYSTEM POWER	LUMINOUS FLUX	ORDER CODE
28.5W	2600lm	180-6420
45W	3610lm	180-6421

#### HIGH EFFICIENCY

SYSTEM POWER	LUMINOUS FLUX	ORDER CODE
21.3W	2730lm	180-6422
25.4W	3160lm	180-6423

### Optical accessories

#### LENSES AND HONEYCOUMB LOUVER

TYPE	Ø-H (mm)	ORDER CODE
linear prismatic lens	75-9	080-6402110P
honeycomb louver	75-9	080-6401118

#### SNOOT

TYPE	Ø-H (mm)	ORDER CODE
short	66-23	080-6403118
medium	66-38	080-6403218
angle	66-38	080-6403318



possibility to combine different optical accessories (max. 2 pieces)

**s.Oliver Store** Munich, DE –  
by Kitzig Interior Design GmbH  
including lighting design







## VARO 110 S

track

**EN** Track light made of die-cast aluminium; surface powder coated; spotlight head 355° rotatable and 90° tiltable; integrated converter in the plastic adapter; high quality reflector with spherical facet finish; precise radiation characteristics with different beam angles; installed and exchanged without tools; optical attachments as accessories; optical attachments can be combined; COB (Chip on Board) technology for maximum efficiency; variants with > 120 lm/W available; no multiple shadows; energy-efficient LEDs with very good colour rendering; adapter for toolless insertion or movement on a variety of 3-phase power tracks

**FR** Spot sur rail en fonte d'aluminium injectée ; surface thermolaquée ; tête de spot rotatif à 355° et orientable à 90° ; convertisseur intégré à l'adaptateur plastique ; réflecteur de grande qualité avec optique facette sphérique ; précision de caractéristique de rayonnement avec divers angles de diffusion ; Installation resp. remplacement sans outil ; éléments optiques comme accessoires ; les accessoires optiques peuvent être combinés entre eux ; avec technologie COB (Chip on Board) pour efficacité maximale ; variantes disponibles avec > 120 lm/W ; pas de formation d'ombres multiples ; LED économes en énergie à restitution de couleur élevée ; adaptateur pour installation ou déplacement sans outil dans différents rails trip hasés

### Quickinfo

3000K, 4000K  
CRI ≥ 90, 3 SDCM  
up to 132lm/W  
L95/50 000h  
non DIM, DALI-2

### Type

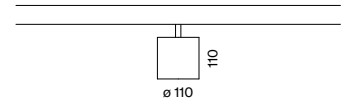

### Colours



### Light distributions



up to 132 lm/W  
(high efficiency)

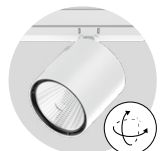

355° rotatable  
90° tiltable

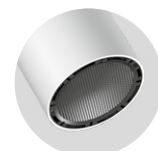

optical  
accessories



combine 2 optical  
accessories

## Order options

COLOUR TEMPERATURE	
3000K	0
4000K	1

CONTROL	
non DIM	1
DALI-2	3

MATERIAL COLOUR	
○ traffic white RAL 9016	7
● jet black RAL 9005	8

BEAM ANGLE	
spot 17°	S
medium 28°	M
flood 38°	F
wide flood 65°	W

## Options on request

LUMINOUS FLUX
> 5000lm

CONTROL
Casambi
DALI-2 (high efficiency)

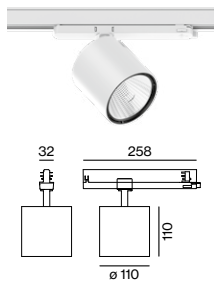

## VARO 110 S track



### TRACK LIGHT

SYSTEM POWER	LUMINOUS FLUX	ORDER CODE
29.6W	3370lm	180-6520::1▲▲
39W	4300lm	180-6521::1▲▲

### HIGH EFFICIENCY

SYSTEM POWER	LUMINOUS FLUX	ORDER CODE
25.7W	3400lm	180-6530::1▲▲
36W	4520lm	180-6531::1▲▲

## Optical accessories

### LENSES AND HONEYCOUMB LOUVER

TYPE	Ø-H (mm)	ORDER CODE
oval lens	106-9	080-6502210
wide flood lens	106-9	080-6502110W
honeycomb louver	106-9	080-6501118

### SNOOT

TYPE	Ø-H (mm)	ORDER CODE
short	97-23	080-6503118
medium	97-38	080-6503218
angle	97-38	080-6503318



possibility to combine different optical accessories (max. 2 pieces)

**Kastner & Öhler, Kaufhaus Tyrol**  
Innsbruck, AT – by DIOMA AG /  
WHIR3 / K&Ö Bauabteilung  
with lighting design by  
VEDDER.LICHTMANAGEMENT





# Versatile profile

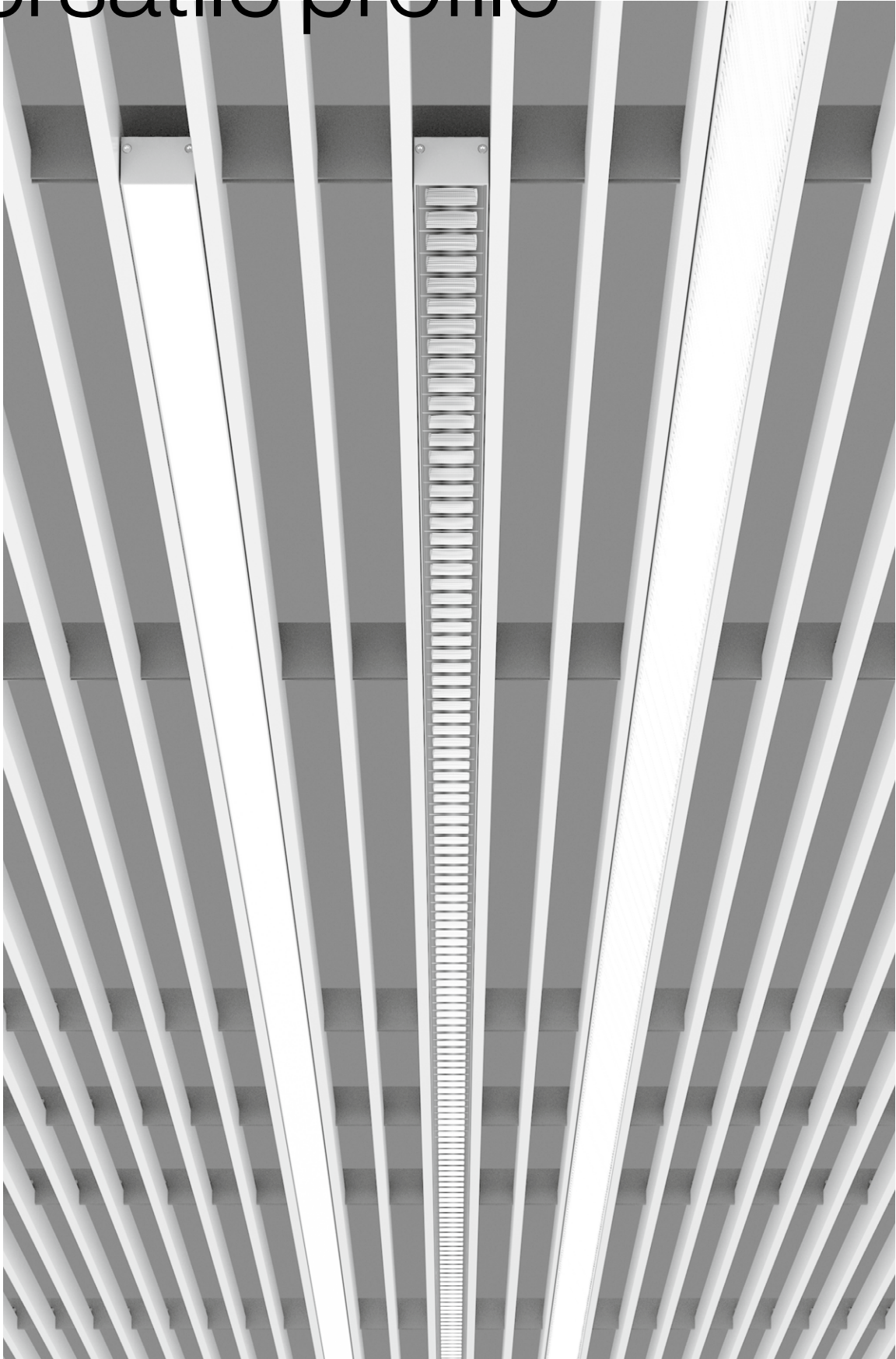



## MILA system

**EN** The MILA system luminaire was specially designed for use with slat ceilings and blends seamlessly into the respective room concept in entrance halls and office buildings. In meeting rooms and offices, the luminaire creates an ideal, screen-appropriate work light thanks to the optional addition of reflectors. In the opal cover variant, MILA is suitable for homogeneous room illumination; a reduced glare value is achieved with the optional microprismatic cover. For continuous lighting systems, the flexible Continuous Cover is the best choice. By adding special sensors, the MILA system luminaire becomes a smart lighting system. The sensors can be freely placed in the slatted ceiling and quickly integrated at a later stage. The collected room utilisation data helps to save energy over the long term.

**FR** Le système de luminaire MILA a été spécialement conçu pour une utilisation dans des plafonds à lamelles et s'intègre parfaitement dans le concept d'espace respectif des halls d'entrée ainsi que dans les bâtiments administratifs. Dans les salles de réunion et les bureaux, le luminaire crée un éclairage de travail idéal et adapté aux écrans grâce à l'ajout facultatif de réflecteurs. En fonction du domaine d'application, MILA est disponible au choix avec un diffuseur opale, gage d'homogénéité de l'éclairage ou avec un cache microprismatique pour une plus grande maîtrise de l'éblouissement. Pour les systèmes d'éclairage continu, le diffuseur Continues flexible est le meilleur choix. Grâce à l'ajout de capteurs spéciaux, MILA se transforme en un système d'éclairage intelligent. Les capteurs peuvent être placés librement dans le plafond à lamelles et être intégrés rapidement par la suite. Les données collectées ici sur l'utilisation de l'espace permettent d'économiser de l'énergie à long terme.

### Type



38

### Mounting



ceiling

### Configuration



linear

### Light distributions

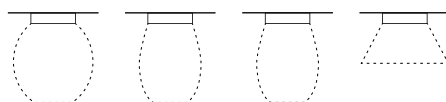

opal

micro-  
prismatic

reflector  
(UGR ≤ 19)

direct



## Advanced sensor technology

**EN** By adding special sensors, the MILA system luminaire becomes a smart lighting system. The sensors can be placed freely and flexibly in the slatted ceiling, and can also be integrated quickly and easily at a later stage. With the ESSENTIAL sensor, the lighting dynamically adapts to the ambient brightness and room activity. In addition, the SENSE sensor measures values for temperature, air quality, humidity, and noise level. These data not only provide important insights into the ambient conditions, but also support energy savings over the long term.

**FR** Grâce à l'ajout de capteurs spéciaux, MILA se transforme en un système d'éclairage intelligent. Les capteurs peuvent être placés librement et de manière flexible dans le plafond à lamelles et être intégrés rapidement et facilement par la suite. Grâce au capteur ESSENTIAL, l'éclairage s'adapte de manière dynamique à la luminosité ambiante et à l'activité de la pièce. En outre, le capteur SENSE permet de mesurer la température, la qualité de l'air, l'humidité et le niveau sonore. Ces données fournissent non seulement des informations importantes sur les conditions environnementales, mais favorisent également les économies d'énergie à long terme.

## Continuous Cover

**EN** Both the opal and the microprismatic cover are available as continuous versions for the MILA system luminaires. This results in remarkable flexibility, as the length of the cover can be adapted exactly to the system. During installation, the Continuous Cover is simply integrated into the profile, avoiding interfering joints, and creating a pleasantly continuous lighting system.

**FR** Les diffuseurs opale et microprismatique sont disponibles en version Continuous pour luminaires MILA. Ils permettent d'obtenir une haute flexibilité, car la longueur du diffuseur peut être adaptée avec précision au système. Lors du montage, le diffuseur Continuous est simplement intégré dans le profilé, ce qui permet d'éviter les points de jonction gênants et de créer un système d'éclairage continu agréable.

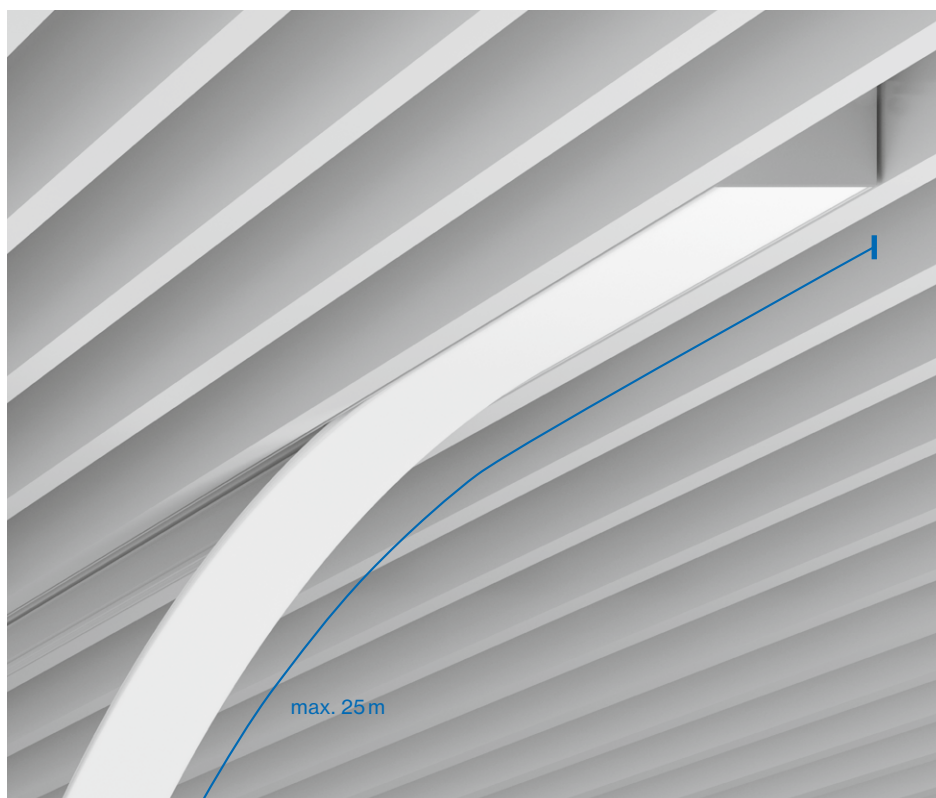

## Inset variety

**EN** Whether workplace lighting or general building areas – the MILA system luminaire can be adapted depending on the area of application. For screen-appropriate task lighting, the  $UGR \leq 19$  glare-reduced reflectors are the right choice. The optionally available opal cover is suitable for homogeneous ambient illumination. The microprismatics with reduced glare value are ideal for pleasantly illuminating entrance areas and corridors.

**FR** Qu'il s'agisse de l'éclairage d'un poste de travail ou de zones générales d'un bâtiment, le système d'éclairage MILA peut être adapté en fonction du domaine d'application. Pour un éclairage du poste de travail adapté à l'écran, les réflecteurs anti-éblouissants  $UGR \leq 19$  sont un choix à privilégier. Le diffuseur opale, disponible en option, permet d'obtenir un éclairage de base homogène. Le diffuseur microprismatique permet une valeur d'éblouissement réduite et est idéal pour éclairer agréablement les entrées et les couloirs.

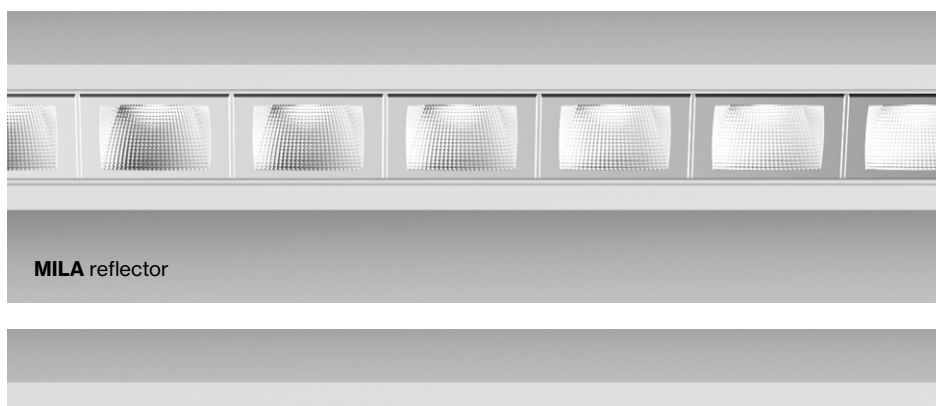

**MILA reflector**



**MILA opal**



**MILA microprismatic**

## Mounting

**EN** MILA can provide the right lighting in any room via sturdy mounting brackets that are hooked into the slatted ceiling. The brackets can be flexibly moved along the luminaire and can thus be positioned as required, or subsequently adjusted. Converters with wiring-through function facilitate electrical installation, as wiring can thus be carried out easily and quickly from one luminaire to another. In addition, the free movement of the converter allows a flexible response to ceiling conditions.

**FR** Grâce à de solides pinces de fixation qui s'accrochent au plafond à lamelles, MILA peut assurer un éclairage adapté dans chaque pièce. Les pinces peuvent être déplacées de manière flexible le long du luminaire et peuvent ainsi être positionnées en fonction des besoins ou être adaptées ultérieurement. Le convertisseur avec fonction wiring-through facilite le montage électrique, car le câblage peut ainsi être effectué facilement et rapidement d'un luminaire à l'autre. De plus, comme le convertisseur se déplace librement, il est possible de réagir en toute flexibilité selon les conditions du plafond.

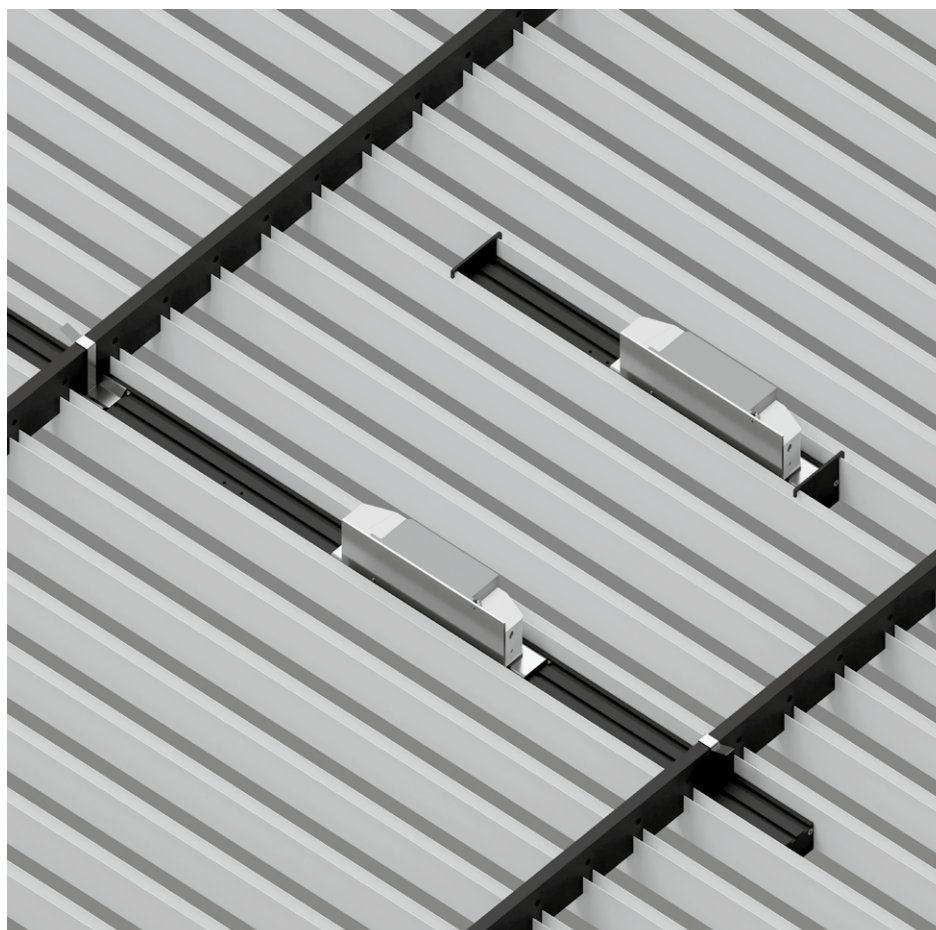

**HAUFE**  
DECKENSYSTEME

## MILA system

ceiling

**EN** Luminaire housing from extruded aluminium profile, angular design; designed for continuous lighting systems; suitable for installation in the HAUFE louvre ceiling system; surface powder coated; HPO (High Performance Opal) cover or microprismatic cover in the length of the light inset or continuous cover (both separately available); optional high gloss reflector with faceted design; converter flexible positionable on the luminaire profile; converter suitable for through-wiring; energy-efficient LEDs with very good colour rendering; optionally sensor inset (ESSENTIAL or SENSE) available as accessory

**FR** Corps de luminaire en profil extrudé en alu, version arête ; conçu pour système d'éclairage continu ; adapté pour le système de plafond à lames de HAUFE ; surface thermolaquée ; cache HPO (High Performance Opal) ou cache microprismatique sur la longueur de l'insert ou cache continu (les deux à commander séparément) ; en option réflecteur ultra-brillant avec optique à facettes ; convertisseur à positionnement flexible sur le profilé de luminaire ; convertisseur adapté pour câblage traversant ; LED économes en énergie à restitution de couleur élevée ; au choix insert à capteur (ESSENTIAL ou SENSE) disponible comme accessoire

### Quickinfo

3000K, 4000K  
CRI  $\geq 90$ , 3 SDCM  
UGR  $\leq 19$  / 65°  $\leq 1500$  cd/m<sup>2</sup>  
up to 115 lm/W  
up to 103 lm/m  
L90 @ 50 000h  
DALI-2  
opal, microprismatic  
reflector (UGR  $\leq 19$ )

### Types

opal / microprismatic

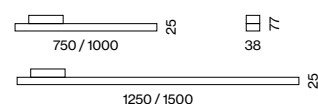

reflector

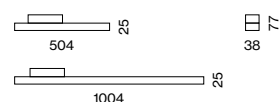

### Colours



### Light distribution



direct



DiiA® standards  
251, 252, 253



suitable for  
HAUFE ceilings

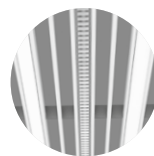

continuous  
lighting system



sensor for  
single mounting



DIN EN 12464-1  
UGR  $\leq 19$



up to 115 lm/W  
(high efficiency)

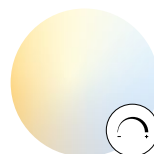

tunable white  
2700-6500K

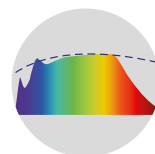

CRI  $\geq 98$   
XPECTRUM

## Order options

<b>COLOUR TEMPERATURE</b>	☐☐
3000K	0
4000K	1

<b>CONTROL</b>	
DALI-2	

<b>MATERIAL COLOUR</b>	☑
○ traffic white RAL 9016	7
● jet black RAL 9005	8

<b>LIGHT OPTIC COVER</b>	☑
opal	H
microprismatic	Z
reflector (UGR ≤ 19)	

## Options on request

<b>COLOUR RENDERING INDEX</b>	
CRI ≥ 98 XPECTRUM	

<b>COLOUR TEMPERATURE</b>	
tunable white 2700–6500K	

<b>SLAT CEILING SOLUTION</b>	
Hunter Douglas	
Interalu SAPPceiling	

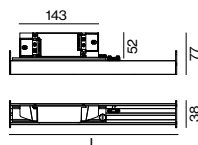

## MILA opal / microprismatic ceiling



### SYSTEM LUMINAIRE

SYSTEM POWER	L (mm)	ORDER CODE
15.8W	750	0 4 5 - 9 0 2 2 ☐☐ 3 ☑
21W	1000	0 4 5 - 9 0 2 3 ☐☐ 3 ☑
25W	1250	0 4 5 - 9 0 2 4 ☐☐ 3 ☑
31W	1500	0 4 5 - 9 0 2 5 ☐☐ 3 ☑

### COVER

TYPE	L (mm)	ORDER CODE
linear	750	0 0 6 - 4 1 0 7 5 1 0 ☐
linear	1000	0 0 6 - 4 1 1 0 0 1 0 ☐
linear	1250	0 0 6 - 4 1 1 2 5 1 0 ☐
linear	1500	0 0 6 - 4 1 1 5 0 1 0 ☐
continuous linear	6000	0 0 6 - 2 1 0 6 0 1 0 ☐
continuous linear	25000	0 0 6 - 2 1 2 5 0 1 0 ☐

LIGHT OPTIC COVER	COLOUR TEMPERATURE	SYSTEM POWER	DELIVERED LUMENS	EFFICACY
opal	3000 K	21W/m	2200lm/m	105lm/W
	4000 K		2420lm/m	115lm/W
microprismatic	3000 K	21W/m	2090lm/m	100lm/W
	4000 K		2300lm/m	110lm/W

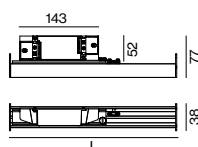

## MILA reflector ceiling

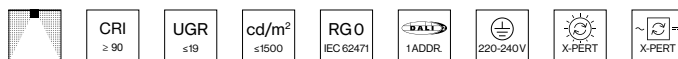

### SYSTEM LUMINAIRE

SYSTEM POWER	L (mm)	ORDER CODE
11W	504	0 4 5 - 9 1 2 1 ☐☐ 3 ☑ R
22W	1004	0 4 5 - 9 1 2 3 ☐☐ 3 ☑ R

LIGHT OPTIC COVER	COLOUR TEMPERATURE	SYSTEM POWER	DELIVERED LUMENS	EFFICACY
reflector (UGR ≤ 19)	3000 K	22W/m	2790lm/m	126lm/W
	4000 K		2950lm/m	133lm/W

## Accessories

### END CAPS

TYPE	ORDER CODE
end caps (pair)	0 4 5 - 9 0 9 0 0 1 ☑

### LINEAR CONNECTOR

TYPE	ORDER CODE
mechanical linear connector	0 4 5 - 9 0 9 1 0 1 0

### SENSOR DALI-2

TYPE	ORDER CODE
ESSENTIAL (brightness & presence)	0 4 5 - 9 0 9 6 0 1 ☑
SENSE (brightness, presence, temperature, sound pressure, humidity, CO <sub>2</sub> )	0 4 5 - 9 0 9 6 0 2 ☑

**Viega GmbH** Attersee, AT –  
by ATP Planungs- und Beteiligungs AG with  
lighting design by Andreas Haidegger

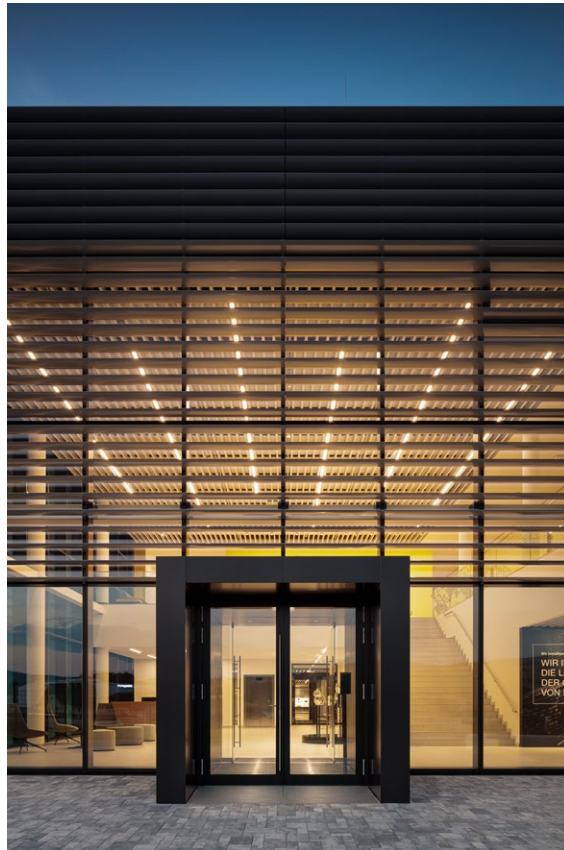



# Spotlight your profile





## FRAME/MINO 40 system

**EN** The FRAME 40 and MINO 40 system luminaires set no limits on profile-based ambient lighting. Thanks to special Flex Insets, the system luminaires can be shortened on-site and thus adapted to all conditions. Corner connectors create continuous lighting systems. For particularly uniform room illumination, the profile luminaires are fitted with an opal cover. In addition, spotlight insets can be selected for elegant accent lighting in corridors or entrance areas. Select a light colour of 3000K, 4000K, or optionally Tunable White, and a colour rendering of up to  $CRI \geq 98$  (XPECTRUM).

**FR** Les systèmes d'éclairage FRAME 40 et MINO 40 montrent une remarquable polyvalence en matière d'éclairage de base et de profilé. Grâce à des inserts Flex spéciaux, les luminaires peuvent être raccourcis sur place et ainsi adaptés à toutes les situations. Et grâce aux raccords d'angle, il est possible d'obtenir un système d'éclairage en continu. Pour un éclairage particulièrement uniforme de la pièce, les luminaires profilés ont été équipés d'un diffuseur opale. De même, les inserts Spots peuvent être rajoutés pour mettre en valeur les couloirs ou les entrées avec élégance. Les options de température de couleur comprennent 3000K, 4000K et Tunable White (en option), avec une capacité de reproduction des couleurs allant jusqu'à un  $IRC \geq 98$  (XPECTRUM).

### Type



40

### Mountings

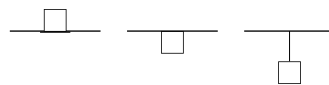
with trim  
recessed

surface

suspended

### Configurations



linear

corner

### Light distributions

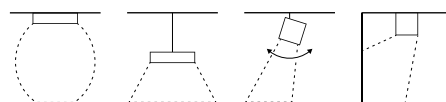

opal

direct

spotlight

wallwasher  
floor

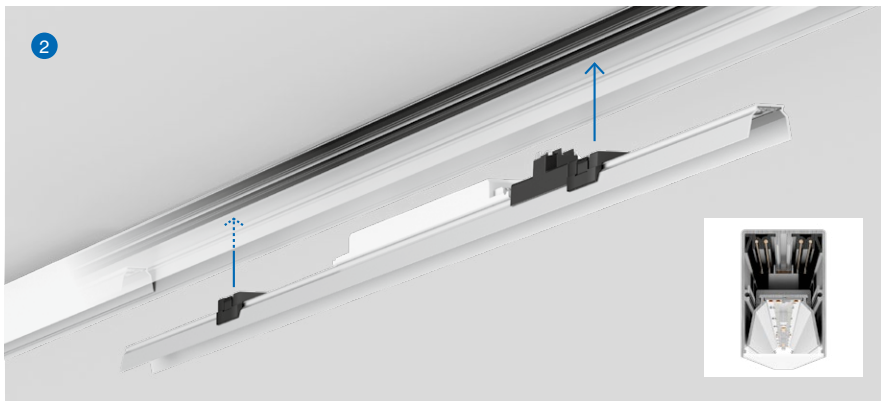
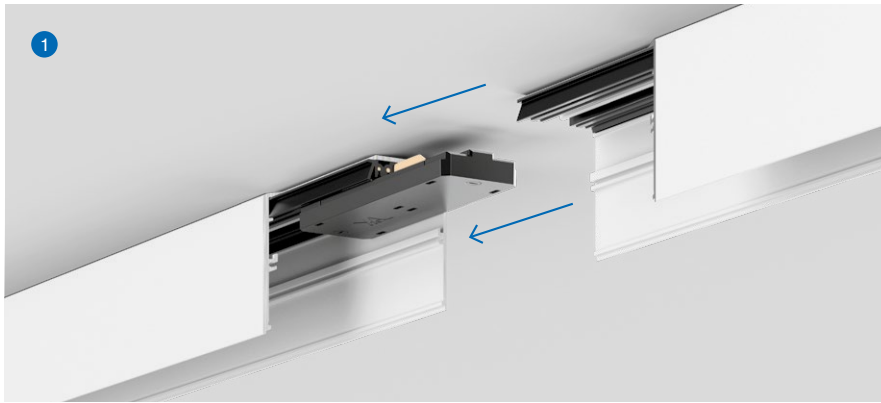

## Easy Mounting

**EN** MINO 40/FRAME 40 is based on a profile with an integrated track, which makes only one power feed point necessary.

(1) Two profiles are connected to each other with mechanical and electrical connectors.

(2) The patent-pending snap-in system allows the inset to be quickly and easily mounted in the profile. This simplifies the installation and maintenance of the system.

(3) The flexible Continuous Cover can be adjusted exactly to the length of the system and simply installed in the profile during mounting. This creates a continuous lighting system without disturbing joints.

**FR** Les solutions MINO 40/FRAME 40 sont basées sur un profilé avec rail d'alimentation intégré, ce qui ne nécessite qu'un seul point de branchement électrique.

(1) Les connecteurs mécaniques et électriques permettent de relier facilement deux profilés entre eux.

(2) Grâce au système Snap-In (en passe d'être breveté), l'insert peut être monté rapidement et facilement dans le profilé. Cela simplifie le montage et l'entretien du système.

(3) Le diffuseur Continuous flexible s'adapte à la longueur exacte du système et peut être facilement intégré dans le profilé lors du montage. Cela permet d'obtenir un système d'éclairage continu sans points de jonction gênants.

## Full-spectrum LED

**EN** XAL's new XPECTRUM LEDs deliver healthy, biologically effective light. The reduced blue light component and increased cyan values reduce the blue light hazard for the eye to daylight-equivalent levels. The resulting non-visual, so-called melanopic light effect, improves concentration and increases sleep quality. The excellent colour rendering of IES TM 30 – 15  $R_f = 98$  and  $R_g = 101$  further helps visual comfort.

**FR** La nouvelle LED XPECTRUM de XAL garantit une lumière saine avec un effet biologique efficace. La part réduite de la lumière bleue et les valeurs de cyan augmentées minimisent le risque de lumière bleue pour l'œil à un niveau similaire à celui de la lumière du jour. L'effet lumineux non visuel qui en résulte, également appelé mélanopique, favorise la concentration et améliore la qualité du sommeil. L'excellent rendu de couleurs d'IES TM 30 – 15  $R_f = 98$  et  $R_g = 101$  permet en outre un meilleur confort visuel.

### XPECTRUM LED

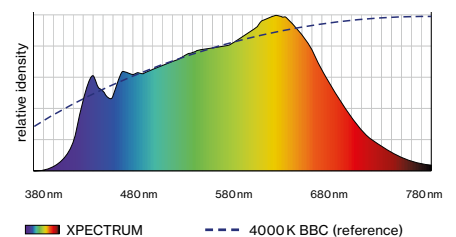

### Commercially available LED 4000 K

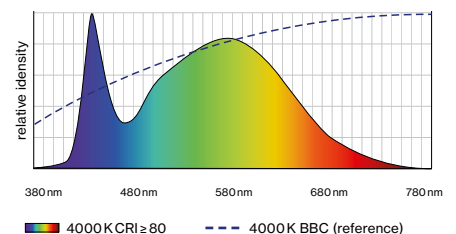

## Precise planning with flex insets

**EN** Your lighting system can be easily adapted to existing room dimensions. You can determine bespoke lengths for MINO 40/FRAME 40. The special flex insets are precisely and flexibly adapted on-site during assembly. Boards are simply cut off at prefabricated break-points. These are positioned at 62.5mm or 125mm, depending on the length of the profile. This gives you a free hand and minimal restrictions in the lighting design.

**FR** Ce système d'éclairage s'adapte facilement aux dimensions existantes de la pièce. Pour MINO 40/FRAME 40, vous pouvez déterminer les longueurs individuellement. Les inserts Flex spéciaux sont adaptés sur place de manière précise et flexible lors du montage : les platines sont simplement séparées à des points de rupture prédéfinis qui se situent à 62,5 mm ou 125 mm, selon la longueur du profilé. Cela vous offre une grande marge de manœuvre et peu de limites dans la planification de l'éclairage.

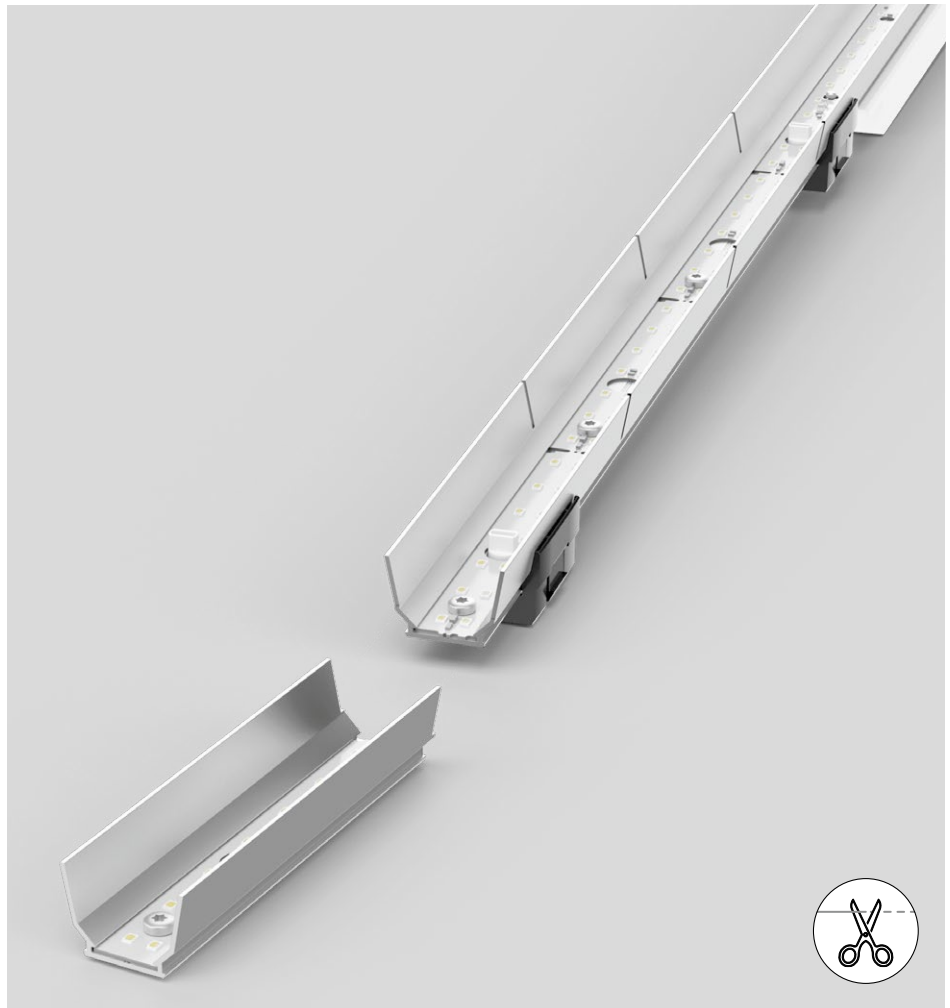

## Spot Insets

**EN** Elegant room accentuation and reduced design: with the new Spot Insets, the system luminaires become convertible luminaires for stylish wall, floor, and ceiling accentuation. In addition, the Wallwasher Floor light inset is perfect for uniform illumination of a blackboard in the classroom, or a corridor. The tool-free installation of the insets is completed in one move, the spotlights can be simply unlocked and snapped into place.

**FR** Accentuation élégante de l'espace et design réduit : avec les nouveaux inserts Spot, le système d'éclairage est modulable pour permettre une mise en valeur stylée des murs, des sols et des plafonds. En outre, l'élément lèche-mur Floor est parfait pour éclairer uniformément un tableau dans une salle de classe ou un couloir. Le montage des inserts se fait sans outils en une seule manipulation : les projecteurs s'installent et se démontent d'un simple clic.



## FRAME 40 system

recessed with trim

**EN** Luminaire housing made of extruded aluminium; recessed luminaire with trim; designed for continuous lighting systems; suitable for ceiling thickness of 8-25 mm; surface powder coated; luminaire profile for mounting available in advance; remaining luminaire components mounted without tools; HPO (High Performance Opal) cover in the length of the light inset or continuous cover (both separately available); pre-assembled power rail for power supply in luminaire profile; voltage tap of the light inset on the power rail; light inset consisting of highly reflective coated extruded profile for improved thermal management; energy-efficient LEDs with very good colour rendering; optionally spotlight modules can be installed

**FR** Corps de luminaire en profil extrudé en aluminium ; luminaire encastré avec bord continu ; conçu pour système d'éclairage continu ; convient aux épaisseurs de plafond de 8-25 mm ; surface thermolaquée ; profilé de luminaire pour montage livrable avant ; composants restants du luminaire montable sans outil ; cache HPO (High Performance Opal) sur la longueur de l'insert ou cache continu (les deux à commander séparément) ; rail d'alimentation prémonté pour l'alim. en tension dans le profilé ; prélèvement de tension de l'insert sur le rail d'alim. ; élément lumineux composé de profilé extrudé laqué hautement réfléchissant pour une gestion thermique améliorée ; LED économes en énergie à restitution de couleur élevée ; des inserts de spot peuvent être installés au choix

### Quickinfo

3000 K, 4000 K  
CRI ≥ 90, 3 SDCM  
up to 2420 lm/m  
up to 123 lm/W  
L85 @ 50 000 h  
DALI-2

### Types

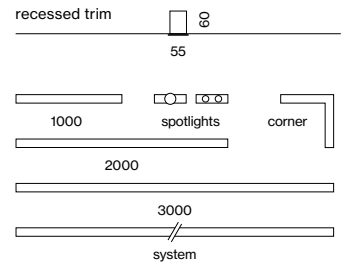

### Colours



### Light distributions

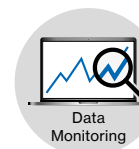

DiiA® standards  
251, 252, 253



snap-in system  
(patent pending)



spotlight  
insets (p.130)



breakable  
flex insets

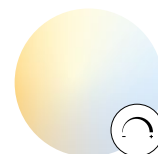

tunable white  
2700–6500 K

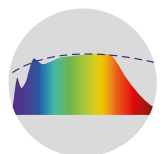

CRI ≥ 98  
XPECTRUM

**Order options**

LED TYPE	
mid lumen	1
high lumen	2

COLOUR TEMPERATURE	
3000K	0
4000K	1

CONTROL	
DALI-2	

MATERIAL COLOUR	
○ traffic white RAL 9016	7
● white aluminium RAL 9006	G
● jet black RAL 9005	8

LENGTH	
1000 mm	1
2000 mm	2
3000 mm	3

LIGHT OPTIC COVER	
opal high performance	

**Options on request**

COLOUR RENDERING INDEX	
CRI ≥ 98 XPECTRUM	

COLOUR TEMPERATURE	
tunable white 2700–6500K	

LIGHT OPTIC COVER	
microprismatic	

**FRAME 40 trim**

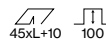

**INSTALLATION CHANNEL**

TYPE	L (mm)	ORDER CODE
channel	1000	042-700201
channel	2000	042-700401
channel	3000	042-700601
channel corner 90°/opal cover	500x500	042-700C01

**LIGHT OPTIC COVER 40**

TYPE	L (mm)	ORDER CODE
linear cover	see left	006-42 L0010H
continuous linear cover	6000	006-2206010H
continuous linear cover	30000	006-2230010H
blind cover	see left	006-42 L001B



**LIGHT INSET 40**

SYSTEM POWER (MID/HIGH LUMEN)	L (mm)	ORDER CODE
12.4/20.1W	1000	042-01 2 37
24.8/40W	2000	042-01 4 37
37/60W	3000	042-01 6 37
12.4/20.1W flex	500–1000	042-01 F 37
24.8/40W flex	1500–2000	042-01 G 37

LED TYPE / COVER	SYSTEM POWER	DELIVERED LM	EFFICACY
mid lumen/opal/4000K	12.4W/m	1430lm/m	116lm/W
high lumen/opal/4000K	20.1W/m	2240lm/m	112lm/W

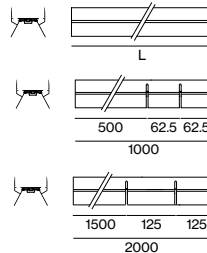

**Spotlight Insets**

see page 130

**Accessories**

**END CAPS**

TYPE	ORDER CODE
end caps (pair)	042-709001



**POWER FEEDER UNIT**

TYPE	ORDER CODE
power feeder unit	042-1093230

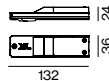

**LINEAR CONNECTOR**

TYPE	ORDER CODE
mechanical linear connector	042-7091110
mechanical & electrical linear connector	042-7091230
opal cover linear connector	042-1091910

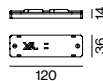

**MOUNTING BRACKET**

TYPE	CEILING THICKNESS (mm)	ORDER CODE
mounting bracket (1 piece)	8-25	042-7092110
mounting bracket (25 pieces)	8-25	042-7092110.25

number of brackets required: length of your system in metres+1

LUMINOUS FLUX value calculated for 4000K, CRI ≥ 90, colour white, cover opal 3000K -5%

**Psychiatrische Klinik Königshof** Krefeld, DE –  
by alsh sander.hofrichter architekten GmbH







## MINO 40 system

ceiling / suspended

**EN** Luminaire housing from extruded aluminium profile, angular design; no visible screws; for lighting systems; powder coated; luminaire profile for mounting available in advance; remaining luminaire components mounted without tools; HPO (High Performance Opal) cover in the length of the light inset or continuous cover (both separately available); pre-assembled power rail for power supply in luminaire profile; voltage tap of the light inset on the power rail; ceiling surface mounting or suspended mounting; height adjustment without tools; with transparent feeder cable; light inset consisting of highly reflective coated extruded profile, improved thermal management; energy-eff. LEDs - very good colour rendering; optionally spotlight modules can be installed

**FR** Corps de luminaire en profil extrudé en alu, version arête ; aucune vis visible ; pour les systèmes d'éclairage ; thermolaquée ; profilé de luminaire pour montage livrable avant ; composants restants du luminaire montable sans outil ; cache HPO (High Performance Opal) sur la longueur de l'insert ou cache continu (les deux à commander séparément) ; rail d'alimentation prémonté pour l'alim. en tension dans le profilé ; prélèvement de tension de l'insert sur le rail d'alim. ; applique plafond ou montage suspendu ; réglage en hauteur sans outil ; conduit d'alimentation transparent inclus ; insert en profilé extrudé peint fortement réfléchissant, gestion améliorée de la température ; LED à haut rend. énerg. - excellent rendu coul. ; des inserts de spot peuvent être installés au choix

### Quickinfo

3000 K, 4000 K  
CRI ≥ 90, 3 SDCM  
up to 2420 lm/m  
up to 123 lm/W  
L85 @ 50000h  
DALI-2

### Types

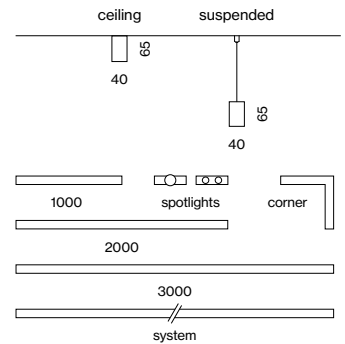

### Colours



### Light distributions

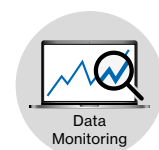

DiiA® standards  
251, 252, 253



snap-in system  
(patent pending)



spotlight  
insets (p.130)



breakable  
flex insets

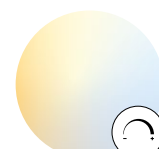

tunable white  
2700–6500 K

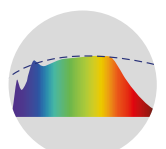

CRI ≥ 98  
XPECTRUM



**Order options**

<b>LED TYPE</b>	
mid lumen	1
high lumen	2

<b>COLOUR TEMPERATURE</b>	
3000K	0
4000K	1

<b>CONTROL</b>	
DALI-2	

<b>MATERIAL COLOUR</b>	
<input type="radio"/> pure white RAL 9010	7
<input checked="" type="radio"/> white aluminium RAL 9006	G
<input type="radio"/> jet black RAL 9005	8
special colours	X

<b>LENGTH</b>	
1000mm	1
2000mm	2
3000mm	3

<b>LIGHT OPTIC COVER</b>	
opal high performance	

<b>ACCESSORY COLOUR</b>	
<input type="radio"/> pure white RAL 9010	7
<input checked="" type="radio"/> jet black RAL 9005	8

**Options on request**

<b>COLOUR RENDERING INDEX</b>	
CRI ≥ 98 XPECTRUM	

<b>COLOUR TEMPERATURE</b>	
tunable white 2700–6500K	

<b>LIGHT OPTIC COVER</b>	
microprismatic	

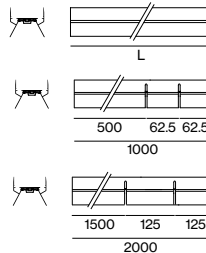

**MINO 40 ceiling/suspended**

**INSTALLATION CHANNEL**

TYPE	L (mm)	ORDER CODE
channel	1000	042-100201
channel	2000	042-100401
channel	3000	042-100601
channel corner 90°/opal cover	500×500	042-100C01

**LIGHT OPTIC COVER 40**

TYPE	L (mm)	ORDER CODE
linear cover	see left	006-42 L 0010H
continuous linear cover	6000	006-2206010H
continuous linear cover	30000	006-2230010H
blind cover	see left	006-42 L 001



**LIGHT INSET 40**

SYSTEM POWER (MID/HIGH LUMEN)	L (mm)	ORDER CODE
12.8/21W	1000	042-01  2  37
25.6/42W	2000	042-01  4  37
38/63W	3000	042-01  6  37
12.8/21W flex	500–1000	042-01  F  37
25.6/42W flex	1500–2000	042-01  G  37

LED TYPE / COVER	SYSTEM POWER	DELIVERED LM	EFFICACY
mid lumen/opal/4000K	12.8W/m	1560lm/m	122lm/W
high lumen/opal/4000K	21W/m	2420lm/m	115lm/W

**Spotlight Insets**

see page 130

**Accessories**

**END CAPS**

TYPE	ORDER CODE
end caps (pair)	042-109001



**POWER FEEDER UNIT**

TYPE	ORDER CODE
power feeder unit	042-1093230

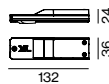

**LINEAR CONNECTOR**

TYPE	ORDER CODE
mechanical linear connector	042-7091110
mechanical & electrical linear connector	042-7091230
opal cover linear connector	042-1091910

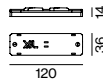

**CEILING FASTENER/CABLE SUSPENSION/CANOPY**

TYPE	L (mm)	ORDER CODE
ceiling fastener	10	050-204111
cable suspension	1500	005-2152110
canopy		005-231121
feeder cable (transparent)		005-2412410

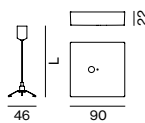

for electrical system configuration see luminaire data sheet at xal.com

LUMINOUS FLUX value calculated for 4000K, CRI ≥ 90, colour white, cover opal 3000K -5%



## SPOTLIGHT insets

profiles 40

**EN** Cylindrical spotlight made of aluminium; powder coated; spotlight can be installed without tools in MINO 40 system or FRAME 40 system; choice of single lamp or double lamps; spotlight head rotatable (WALLWASHER/FLOOR) or rotatable and tiltable (SPOTLIGHT); converter in the adapter; with optional high quality lens system with precise radiation characteristic; or high quality, aluminium, vapour deposition coated reflector with faceted design; precise radiation characteristics with different beam angles; optional asym. light distribution; good glare reduction due to recessed light point plane; optical attachments as accessories; COB (Chip on Board) technology or high power LEDs - maximum efficiency; no multiple shadows; energy-eff. LEDs - very good colour rendering

**FR** Spot cylindrique en aluminium ; thermolaquée ; spot intégrable sans outil au système MINO 40 ou système FRAME 40 ; au choix monoflamme ou biflamme ; tête de spot rotatif (WALLWASHER/FLOOR) ou pivotant et orientable (SPOTLIGHT) ; convertisseur dans l'adaptateur ; également possible avec une optique de lentilles de haute qualité présentant des caractéristiques de rayonnement précises ; ou réflecteur de grande qualité, métallisée à l'aluminium avec optique facette ; précision de caractéristique de rayonnement avec divers angles de diffusion ; en option diffusion asym. de la lumière ; bon anti-éblouissement grâce aux points lumineux en retrait ; éléments optiques comme accessoires ; technologie COB (Chip on Board) ou High-Power-LED - efficacité maximale ; pas d'ombres multiples ; LED à haut rend. éner. - excellent rendu coul.

### Quickinfo

3000K, 4000K  
CRI ≥ 90, 2 SDCM  
spotlight 32 up to 79 lm/W  
spotlight 45 up to 85 lm/W  
L80 @ 50 000h  
DALI-2

### Types

SPOTLIGHT 32

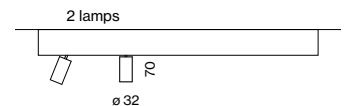

SPOTLIGHT 45

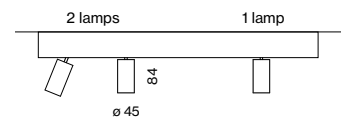

SPOTLIGHT 45 wallwasher floor

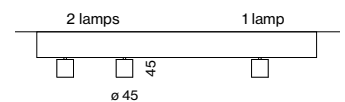

### Colours



### Light distributions



DiiA® standards  
251, 252, 253



snap-in system  
(patent pending)



wallwasher floor  
360° rotatable



wallwasher  
floor

**Order options**

<b>COLOUR TEMPERATURE</b>	☼☼
3000K	0
4000K	1

<b>CONTROL</b>	
DALI-2	

<b>MATERIAL COLOUR</b>	☑
○ traffic white RAL 9016	7
● jet black RAL 9005	8

<b>BEAM ANGLE</b>	
<b>SPOTLIGHT 32</b>	▲
spot 18°	S
medium 23°	M
flood 37°	F

<b>BEAM ANGLE</b>	
<b>SPOTLIGHT 45</b>	▲
spot 14°	S
medium 24°	M
flood 39°	F

**SPOTLIGHT 32**

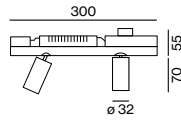

**2 LAMPS**

<b>SYSTEM POWER</b>	<b>LUMINOUS FLUX</b>	<b>ORDER CODE</b>
20.6 W	2 × 810 lm	0 4 2 - 0 6 1 0 :: 3 ▲
honeycomb louver		0 0 7 - 1 9 6 5 1 8 8

**SPOTLIGHT 45**

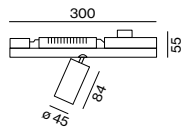

**1 LAMP**

<b>SYSTEM POWER</b>	<b>LUMINOUS FLUX</b>	<b>ORDER CODE</b>
15 W	spot 1060 lm	0 4 2 - 0 5 2 0 :: 3 ▲ S
15.9 W	medium, flood 1340 lm	0 4 2 - 0 5 2 0 :: 3 ▲
honeycomb louver		0 0 7 - 1 9 6 5 1 8 8

**2 LAMPS**

<b>SYSTEM POWER</b>	<b>LUMINOUS FLUX</b>	<b>ORDER CODE</b>
30 W	spot 2 × 1060 lm	0 4 2 - 0 6 2 0 :: 3 ▲ S
32 W	medium, flood 2 × 1340 lm	0 4 2 - 0 6 2 0 :: 3 ▲
honeycomb louver		0 0 7 - 1 9 6 5 1 8 8

**SPOTLIGHT 45 wallwasher / floor**

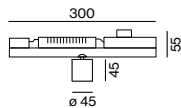
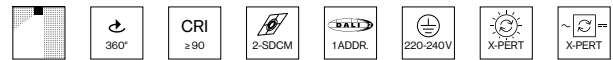

**1 LAMP**

<b>SYSTEM POWER</b>	<b>LUMINOUS FLUX</b>	<b>ORDER CODE</b>
9 W	659 lm	0 4 2 - 0 5 2 0 :: 3 ▲ W

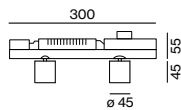

**2 LAMPS**

<b>SYSTEM POWER</b>	<b>LUMINOUS FLUX</b>	<b>ORDER CODE</b>
15.9 W	2 × 659 lm	0 4 2 - 0 6 2 0 :: 3 ▲ W

LUMINOUS FLUX value calculated for 4000K, CRI ≥ 90, colour white, medium 3000K -5 %

**Corridor**  
Visualisation



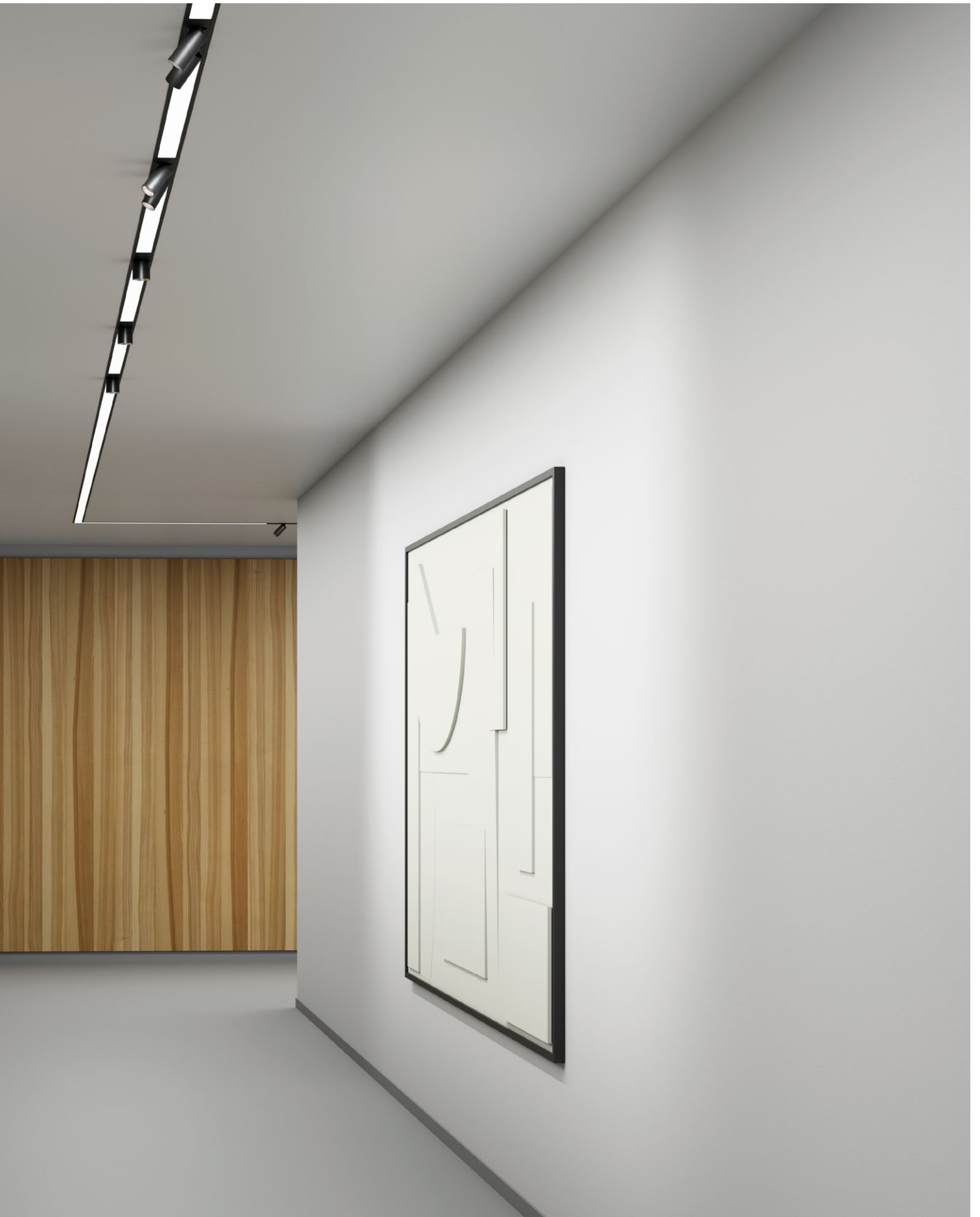

## Get in contact

<sup>EN</sup> We develop and perfect projects in dialogue with the architects and planners to make them unique. We see ourselves as your partner. From lighting design, the right product selection and control system to commissioning and maintenance, we are at your side throughout your project. Let's talk about your project: [\*\*office@xal.com\*\*](mailto:office@xal.com)

<sup>FR</sup> Notre mission consiste à concevoir des projets et à les perfectionner en concertation avec les architectes et les planificateurs, afin de les rendre uniques. Nous envisageons notre rôle comme celui d'un partenaire à votre service. De la planification de l'éclairage à la mise en service et à l'entretien, en passant par le bon choix du produit et de la commande, nous sommes à vos côtés dans toutes les phases de votre projet. Parlons ensemble de votre projet : [\*\*office@xal.com\*\*](mailto:office@xal.com)

### **XAL Headquarters**

XAL GmbH  
Auer-Welsbach-Gasse 36  
8055 Graz  
**AUSTRIA**  
T +43.316.3170  
[office@xal.com](mailto:office@xal.com)

All locations:  
[\*\*xal.com/contacts\*\*](http://xal.com/contacts)

## List of photographers

Kris Dekeijser (Cover), Kurt Kuball (p. 52-53 | 86-87 | 98-99 | 118-119), Tim Ertl (p. 66-67), Z. Gataric Fotografie (p. 90), Dan Preston (p. 91), Oberpollinger | The KaDeWe Group (p. 95 | 100-101), Jens Pfisterer (p. 110-111), Huy Nguyen (p. 106-107), Markus Bachmann (p. 126-127)

## Legal notices

<sup>EN</sup> Information in this catalogue was valid at the time of printing, is non-binding, and should be used for information purposes only. We are not liable for products that differ from illustrations or information. We reserve the right to make changes to our products at any time. All orders will be accepted exclusively in accordance with our general terms and conditions of business and delivery. The latest version of these terms and conditions is available at [www.xal.com](http://www.xal.com).

<sup>FR</sup> Les données de ce catalogue correspondent à la situation au moment de l'impression, elles ne sont pas contraignantes et ont uniquement un but informatif. XAL n'est pas responsable des écarts constatés entre un produit et ses images ou données. Nous nous réservons le droit d'apporter des modifications à nos produits à tout moment. Toutes les commandes sont prises conformément à nos conditions générales de vente et de livraison, que vous pouvez retrouver au [www.xal.com](http://www.xal.com), et dans leur version en vigueur.

